

IMB-M47-R680E

User's Manual

ATX Motherboard with 12/13/14th Gen Intel® Core™ i9/i7/i5/i3 Processors
and Intel® R680E Chipset

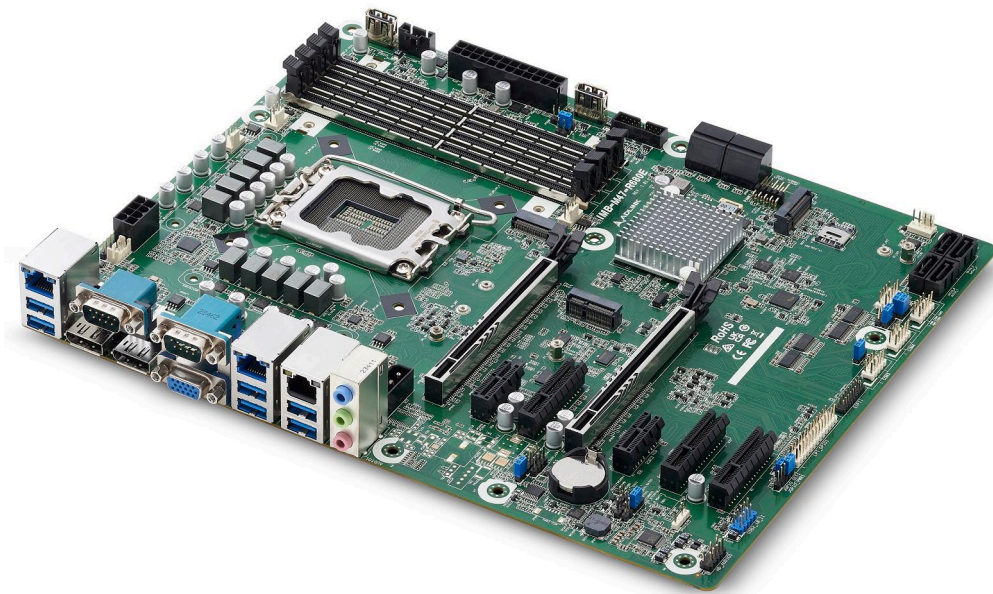

Manual Rev.: 1.0
Revision Date: April 9, 2024
Part Number: 50M-13016-2000

Preface

Copyright

Copyright 2024 ADLINK Technology, Inc. This document contains proprietary information protected by copyright. All rights are reserved. No part of this manual may be reproduced by any mechanical, electronic, or other means in any form without prior written permission of the manufacturer.

Disclaimer

The information in this document is subject to change without prior notice in order to improve reliability, design, and function and does not represent a commitment on the part of the manufacturer. In no event will the manufacturer be liable for direct, indirect, special, incidental, or consequential damages arising out of the use or inability to use the product or documentation, even if advised of the possibility of such damages.

Environmental Responsibility

ADLINK is committed to fulfill its social responsibility to global environmental preservation through compliance with the European Union's Restriction of Hazardous Substances (RoHS) directive and Waste Electrical and Electronic Equipment (WEEE) directive. Environmental protection is a top priority for ADLINK. We have enforced measures to ensure that our products, manufacturing processes, components, and raw materials have as little impact on the environment as possible. When products are at their end of life, our customers are encouraged to dispose of them in accordance with the product disposal and/or recovery programs prescribed by their nation or company.

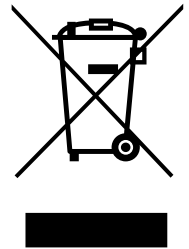

Battery Labels (for products with battery)

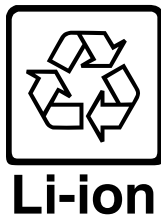
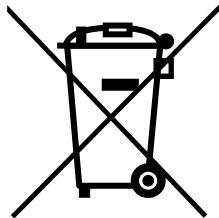

California Proposition 65 Warning



WARNING: This product can expose you to chemicals including acrylamide, arsenic, benzene, cadmium, Tris(1,3-dichloro-2-propyl)phosphate (TDCPP), 1,4-Dioxane, formaldehyde, lead, DEHP, styrene, DINP, BBP, PVC, and vinyl materials, which are known to the State of California to cause cancer, and acrylamide, benzene, cadmium, lead, mercury, phthalates, toluene, DEHP, DIDP, DnHP, DBP, BBP, PVC, and vinyl materials, which are known to the State of California to cause birth defects or other reproductive harm. For more information go to www.P65Warnings.ca.gov.

Trademarks

Product names mentioned herein are used for identification purposes only and may be trademarks and/or registered trademarks of their respective companies.

Revision History

Revision	Description	Date	By
1.0	Initial release	2024-04-09	RA

Table of Contents

Preface	ii
Table of Contents	iv
List of Figures	vi
List of Tables	vii
1 Introduction	1
1.1 Packing List	1
1.2 Optional Accessories	1
2 Specifications	3
2.1 Core System	3
2.2 1.1 I/O Interface	4
2.3 Video	4
2.4 Audio	5
2.5 LAN	5
2.6 Temperatures	5
2.7 Humidity	5
2.8 Certificate (EMC)	5
2.9 Form Factor	5
2.10 Operating Systems	5
2.11 Functional Block Diagram	6
3 Mechanical Layout	7
3.1 Connector Locations	7
3.2 Mechanical Dimensions	11
4 Connector Pinouts	13
4.1 Rear IO Connectors	13
4.2 Onboard Headers / Connectors	15
4.3 Jumper and Switch Settings	20
4.4 Expansion Slots	22
5 Driver Installation	25
6 UEFI Setup	27
6.1 Menu Structure	27
6.2 Main Menu	28
6.3 Advanced Menu	29
6.4 Hardware Health Event Monitoring Screen	46
6.5 Security Screen	47

6.6	Boot Screen	51
6.7	Exit Screen	52
Safety Instructions.....		53
Getting Service.....		54

List of Figures

Figure 1: Functional Block Diagram.....	6
Figure 2: IO Panel Connector Locations.....	7
Figure 3: Onboard Connector Locations.....	8
Figure 4: Mechanical Dimensions.....	11
Figure 5: Mechanical Dimensions - IO Panel.....	12

List of Tables

Table 1: IO Panel Connector Definitions.....	7
Table 2: Onboard Connector Definitions.....	9

This page intentionally left blank.

1 Introduction

ADLINK IMB-M47-R680E ATX is an industrial motherboard supporting 12/13/14th Generation Intel® Core™ i9/i7/i5/i3 desktop processors, an Intel® R680E Chipset, and 7 PCIe expansion slots to provide a cost-competitive embedded computing solution. It includes high-speed data transfer interfaces such as PCIe 5.0, USB 3.2 Gen2, and SATA 6 Gb/s (SATA III), and dual-channel DDR5 up to 4400 MHz RAM for industrial automation applications. With industrial-grade I/O port design, the IMB-M47-R680E offers a significant competitive advantage for embedded computing applications in terms of device compatibility, durable connectivity, and extreme environment readiness.

1.1 Packing List

- IMB-M47-R680E ATX motherboard
- Rear I/O shield
- M.2 screw kit

1.2 Optional Accessories

- CPU cooler for 65W CPU (Part Number: 32-20976-0000-A0)
- CPU cooler for 125W CPU (Part Number: 32-21041-0000-A0)
- 2-port USB 2.0 cable with bracket (Part Number: 30-25010-3010)
- 2-port USB 3.0 cable with bracket (Part Number: 30-25046-0100)
- 1-port LPT cable with bracket (Part Number: 30-25019-2000)
- 2-port COM cable with bracket (Part Number: 30-25116-0000-A0)

This page intentionally left blank.

2 Specifications

2.1 Core System

- **CPU:**
 - Intel® Core™ i9-14900, up to 5.80 GHz, 36M Cache, 65W
 - Intel® Core™ i9-14900T, up to 5.50 GHz, 36M Cache, 35W
 - Intel® Core™ i7-14700T, up to 5.20 GHz, 33M Cache, 35W
 - Intel® Core™ i7-14700, up to 5.40 GHz, 33M Cache, 65W
 - Intel® Core™ i5-14400, up to 4.70 GHz, 20M Cache, 65W
 - Intel® Core™ i5-14400T, up to 4.50 GHz, 20M Cache, 35W
 - Intel® Core™ i5-14500, up to 5.00 GHz, 24M Cache, 65W
 - Intel® Core™ i5-14500T, up to 4.80 GHz, 24M Cache, 35W
 - Intel® Core™ i3-14100T, up to 4.40 GHz, 12M Cache, 35W
 - Intel® Core™ i3-14100, up to 4.70 GHz, 12M Cache, 65W
 - Intel® Core™ i9-13900TE, up to 5.00 GHz, 24 Core, 36M Cache, 35W
 - Intel® Core™ i9-13900E, up to 5.20 GHz, 24 Core, 36M Cache, 65W
 - Intel® Core™ i7-13700E, up to 5.10 GHz, 16 Core, 30M Cache, 65W
 - Intel® Core™ i7-13700TE, up to 4.80 GHz, 16 Core, 30M Cache, 35W
 - Intel® Core™ i5-13500TE, up to 4.50 GHz, 14 Core, 24M Cache, 35W
 - Intel® Core™ i5-13500E, up to 4.60 GHz, 14 Core, 24M Cache, 65W
 - Intel® Core™ i3-13100E, up to 4.40 GHz, 4 Core, 12M Cache, 65W
 - Intel® Core™ i3-13100TE, up to 4.10 GHz, 4 Core, 12M Cache, 35W
 - Intel® Core™ i9-12900E, up to 5.00 GHz, 16 Core, 30M Cache, 65W
 - Intel® Core™ i9-12900TE, up to 4.80 GHz, 16 Core, 30M Cache, 35W
 - Intel® Core™ i7-12700E, up to 4.80 GHz, 12 Core, 25M Cache, 65W
 - Intel® Core™ i7-12700TE, up to 4.60 GHz, 12 Core, 25M Cache, 35W
 - Intel® Core™ i5-12500E, up to 4.50 GHz, 6 Core, 18M Cache, 65W
 - Intel® Core™ i5-12500TE, up to 4.30 GHz, 6 Core, 18M Cache, 35W
 - Intel® Core™ i3-12100E, up to 4.20 GHz, 4 Core, 12M Cache, 60W
 - Intel® Core™ i3-12100TE, up to 4.00 GHz, 4 Core, 12M Cache, 35W
 - Intel® Pentium® Gold G7400E, up to 3.60 GHz, 2 Core, 6M Cache, 46W
 - Intel® Pentium® Gold G7400TE, up to 3.00 GHz, 2 Core, 6M Cache, 35W
 - Intel® Celeron® G6900E, up to 3.00 GHz, 2 Core, 4M Cache, 46W
 - Intel® Celeron® G6900TE, up to 2.40 GHz, 2 Core, 4M Cache, 35W
- **Chipset:** Intel® R680E Express Chipset
- **Memory:** 4x 288-pin Dual Channel DDR5 up to 4400 MHz, maximum 128GB
- **BIOS:** AMI® UEFI BIOS, 256 Mb SPI Flash Memory

- **Hardware Monitor:** CPU voltage
 - +3.3V voltage
 - +5V voltage
 - +12V voltage
 - CPU temperature
 - System temperature
 - CPU fan speed
 - System fan speed

2.2 1.1 I/O Interface

- **Expansion slots:**
 - 2x PCIe Gen5 (single card at x16 PCIE1; dual cards at x8 PCIE1 / x8 PCIE4)
 - 2x PCIe x4 (Gen4)
 - 1x PCIe x4 (Gen3)
 - 2x PCIe x1 (Gen3)
- **SATA:** 8x SATA 6.0 Gb/s connectors, Intel® software RAID 0/1/5/10 support
- **USB:**
 - 5x USB 3.2 Gen2 connectors (rear)
 - 2x USB 3.1 via pin headers
 - 2x USB 2.0 via pin headers
 - 2x USB 2.0 vertical connectors
- **COM:** 2x RS-232/422/485 (rear), 4x RS-232 pin headers
- **Parallel Port:** 1x LPT pin header
- **PS/2 Combo Port:** 1x PS/2 keyboard/mouse pin header
- **DIO:** 8-bit GPIO (shared with LPT header)
- **TPM:** TPM 2.0
- **M.2 connectors:**
 - 1x M.2 (Key E, 2230) with PCIe x1, USB 2.0 and CNVi for Wireless
 - 1x M.2 (Key B, 3042/3052) with PCIe x1 / USB 3.2 Gen1 / USB 2.0 and SIM socket for 4G/5G
 - 1x M.2 (Key M, 2242/2260/2280/25110) with PCIe x4 Gen4

2.3 Video

- **Interfaces:**
 - VGA: 1x VGA connector (rear I/O), resolution up to 1920 x 1200@60Hz
 - DP1.4a: 2x DP++ connectors (rear I/O), resolution up to 4096 x 2160@60Hz

2.4 Audio

- **Audio Codec:** Realtek® ALC897
- **Interfaces:** 1x Mic-in, 1x Line-in, and 1x Line-out connectors (rear)

2.5 LAN

- **LAN1:** Intel® I226LM with 10/100/1000/2500 Mbps
- **LAN2:** Intel® I226LM with 10/100/1000/2500 Mbps
- **LAN3:** Intel® I226LM with 10/100/1000/2500 Mbps

2.6 Temperatures

- **Operating Temperature:** 0°C to 60°C
- **Storage Temperature:** -40°C to 85°C

2.7 Humidity

- 60°C at 90% RH, non-condensing

2.8 Certificate (EMC)

- CE/FCC Class B

2.9 Form Factor

- **ATX:** 305 mm x 244 mm (W x L)

2.10 Operating Systems

- Microsoft® Windows® 10, 64-bit
- Microsoft® Windows® 11, 64-bit

2.11 Functional Block Diagram

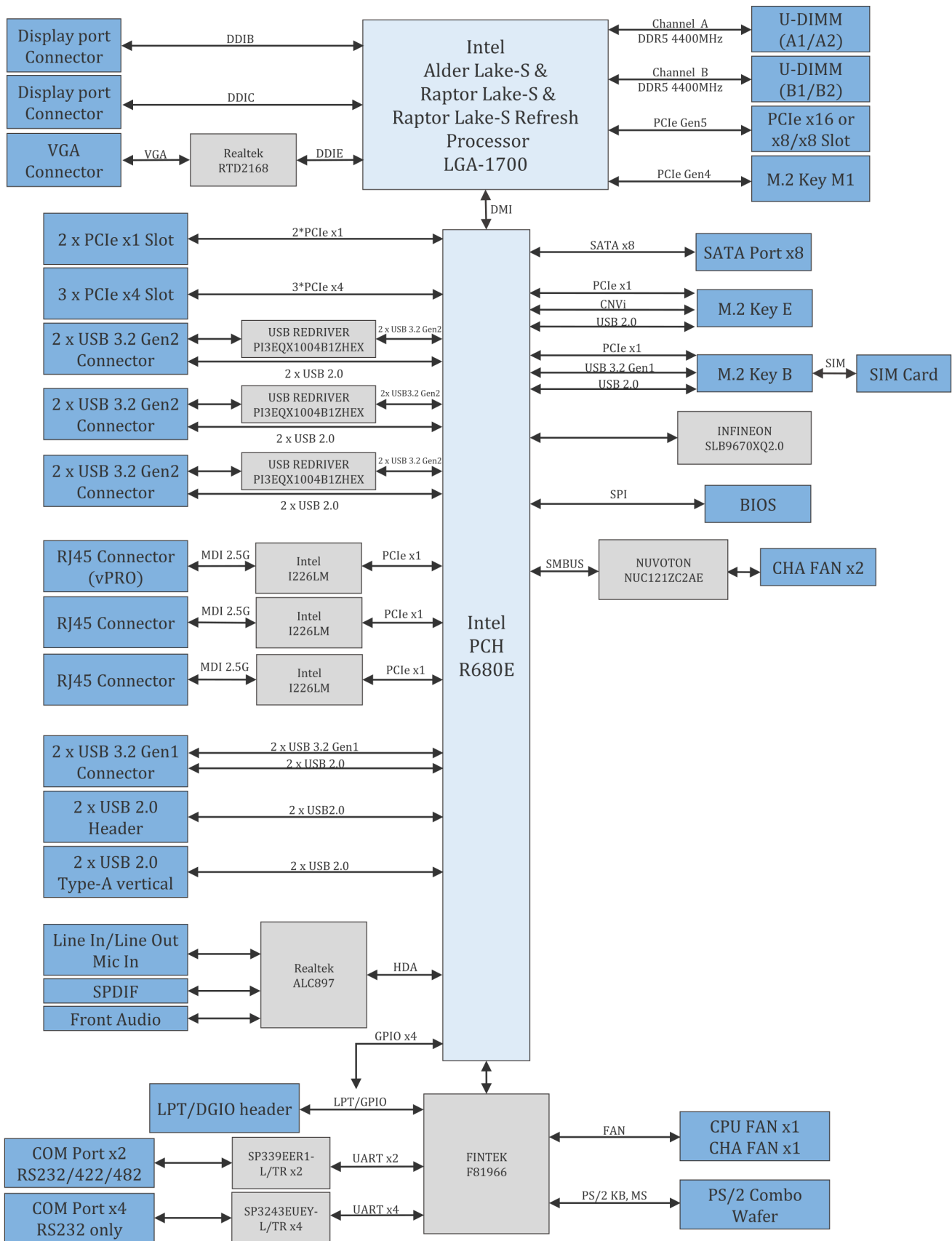

Figure 1: Functional Block Diagram

3 Mechanical Layout

3.1 Connector Locations

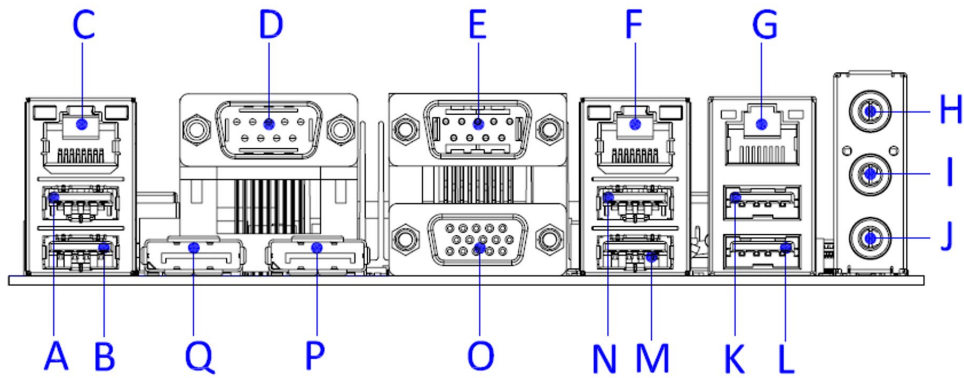

Figure 2: IO Panel Connector Locations

Table 1: IO Panel Connector Definitions

IO Panel Connectors	
Item	Description
A	USB 3.2 Gen2 Port
B	USB 3.2 Gen2 Port
C	RJ45 LAN Port (LAN3)
D	COM Port (COM1) (RS-232/422/485)
E	COM Port (COM2) (RS-232/422/485)
F	RJ45 LAN Port (LAN2)
G	RJ45 LAN Port (LAN1)
H	Line in (light blue)
I	Line out (lime)
J	Mic in (pink)
K	USB 3.2 Gen2 Port
L	USB 3.2 Gen2 Port
M	USB 3.2 Gen2 Port
N	USB 3.2 Gen2x2 Type-C Port
O	D-sub Port (VGA1)
P	DisplayPort (DP1)
Q	DisplayPort (DP2)

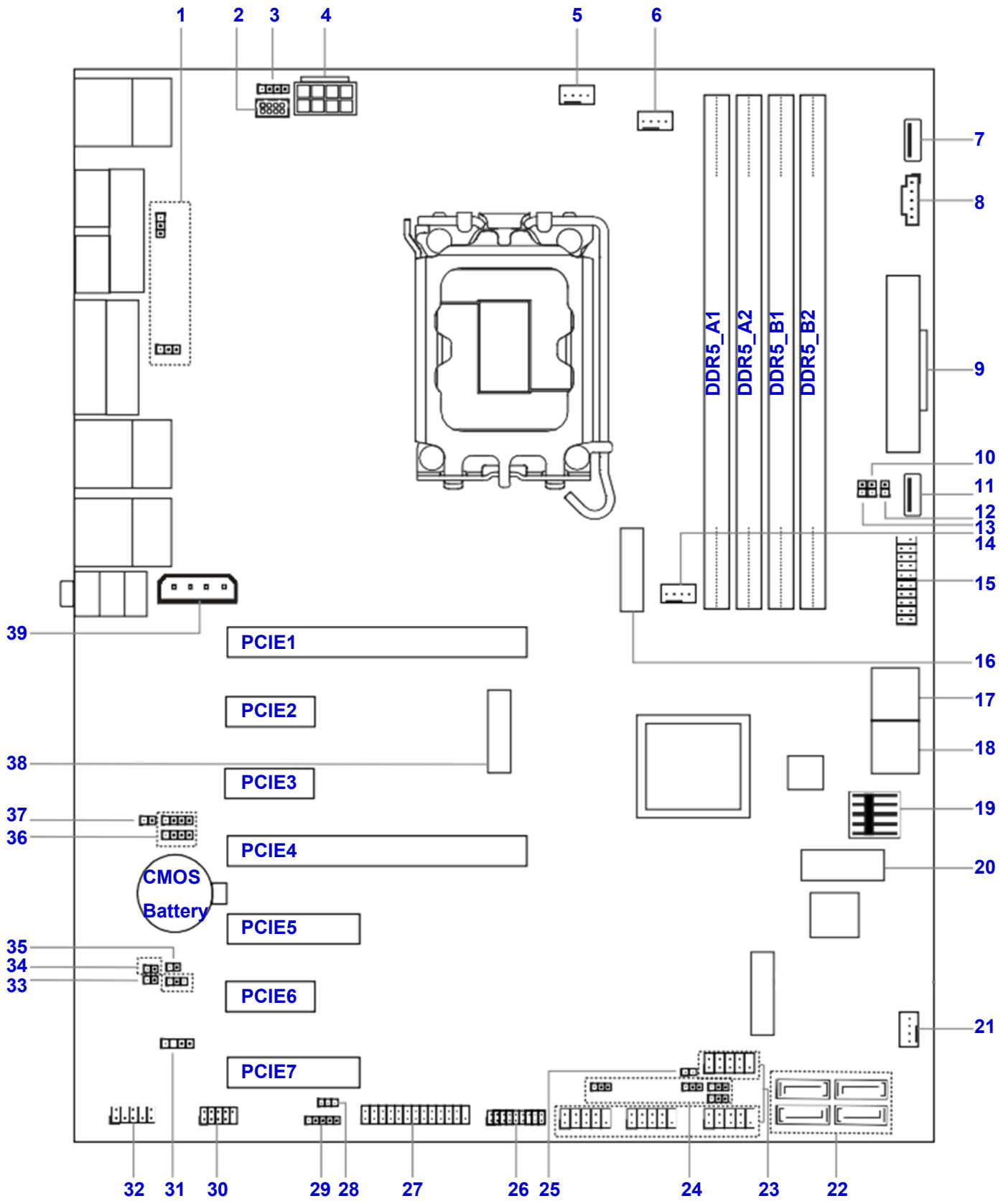

Figure 3: Onboard Connector Locations

Table 2: Onboard Connector Definitions

Onboard Connectors		
Item	Description	Remarks
1	COM Port Pin9 PWR Setting Jumpers PWR_COM1~2 (For COM Port1~2)	
2	PS/2 Keyboard/Mouse Header	
3	LAN LED Headers I226_LED3 (For LAN3 Port)	
4	ATX 12V Power Connector	ATX12V1
5	Chassis Fan Connectors (+12V)	CHA_FAN1
6	CPU Fan Connector (+12V)	
7	USB 2.0 Port	USB2_13
8	PSU_SMB1	
9	24-pin ATX Power Input Connector	ATXPWR1
10	Chassis Intrusion Header	CI1
11	USB 2.0 Port	USB2_12
12	PWR LOSS Jumper	PWR_LOSS1
13	Chassis Intrusion Header	CI2
14	Chassis Fan Connector (+12V)	CHA_FAN3
15	USB 3.2 Gen1 Header	USB3_5_6
16	M.2 Key-M Socket	M2_M1
17	SATA3 Connectors	SATA3_4~5
18	SATA3 Connectors	SATA3_6~7
19	System Panel Header	PANEL1
20	M.2 Key-B Socket	M2_B1
21	Chassis Fan Connector (+12V)	CHA_FAN2
22	SATA3 Connectors	SATA3_0~3
23	COM Port Headers (RS232)	COM3~6
24	COM Port Pin9 PWR Setting Jumpers PWR_COM3~6 (For COM Port3~6)	
25	ATX/AT Mode Jumper	SIO_AT1
26	ESPI Header	ESPI1
27	Printer Port / GPIO Header	LPT_GPIO1
28	Digital Input / Output Default Value Setting	JGPIO_SET1
29	Digital Input / Output Power Select	JGPIO_PWR1
30	USB 2.0 Header	USB2_10_11
31	SPDIF Header	SPDIF1
32	Front Panel Audio Header	HD_AUDIO1
33	Buzzer	BUZZ2

Onboard Connectors		
Item	Description	Remarks
34	Clear CMOS Headers	CLRMOS1~2
35	PWR_BAT1	
36	LAN LED Headers (For LAN1~2 Port)	I226_LED1 I226_LED2
37	DACC1	
38	M.2 Key-E Socket	M2_E1
39	PCIe Power Connector	PCIE_PWR1

3.2 Mechanical Dimensions

Top View

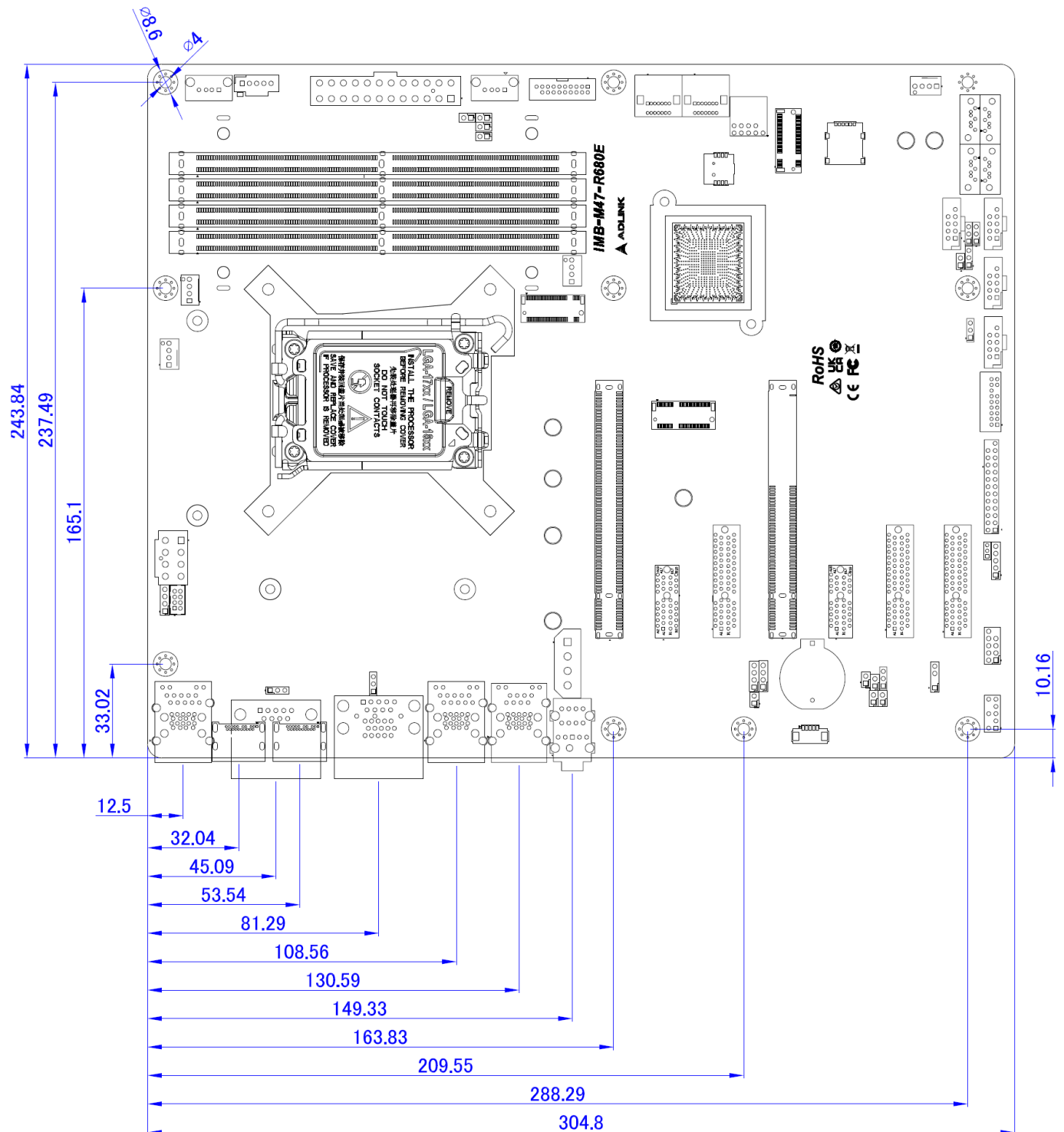

Dimensions: mm

Figure 4: Mechanical Dimensions

Side View

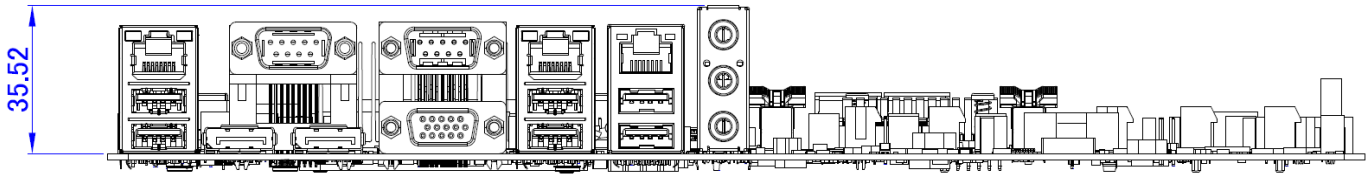

Dimensions: mm

Figure 5: Mechanical Dimensions - IO Panel

4 Connector Pinouts

See 3.1 Connector Locations on page 7 for connector locations.

4.1 Rear IO Connectors

4.1.1 DisplayPort

Pin	Signal	Pin	Signal
1	CN_DDPx0+	2	GND
3	CN_DDPx0-	4	CN_DDPx1+
5	GND	6	CN_DDPx1-
7	CN_DDPx2+	8	GND
9	CN_DDPx2-	10	CN_DDPx3+
11	GND	12	CN_DDPx3-
13	CN_DDPx_AUX_SEL	14	CN_DDPx_CONFIG2
15	CN_DDPx_AUX+	16	GND
17	CN_DDPx_AUX-	18	CN_DDPx_HPDP
19	GND	20	+V3.3_DDPx_PWR_CN

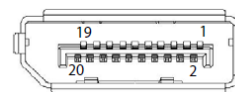

4.1.2 VGA Connector

Pin	Signal	Pin	Signal
1	VGA_CON_RED	2	VGA_CON_GREEN
3	VGA_CON_BLUE	4	NC
5	GND	6	GND
7	GND	8	GND
9	+5V_HDMI	10	GND
11	NC	12	VGA_DDCDAT
13	VGA_CON_HS	14	VGA_CON_VS
15	VGA_DDCCLK		

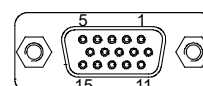

4.1.3 COM 1-2 Connectors

COM1 and COM2 ports (RS232/422/485) can be adjusted in BIOS setup utility > Advanced Screen > Super IO Configuration.

Pin	Signal		
	RS-232	RS-422	RS-485
1	DCD#	Tx-	Tx/Rx-
2	RxD	Tx+	Tx/Rx+
3	TxD	Rx+	N/A
4	DTR#	Rx-	N/A
5	GND	GND	GND
6	DSR#	N/A	N/A
7	RTS#	N/A	N/A
8	CTS#	N/A	N/A
9	No Power / 5V / 12V	N/A	N/A

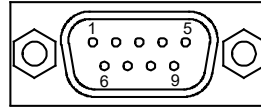

4.1.4 Ethernet Connectors (LAN1, LAN2, LAN3)

Three 10/100/1000/2500 Mbps LAN Ethernet controllers based on Intel® i226LM, support PXE and WOL. LAN2 supports vPro.

Pin	10BASE-T/100BASE-TX	1000BASE-T
1	TX+	LAN_MDI0+
2	TX-	LAN_MDI0-
3	RX+	LAN_MDI1+
4	--	LAN_MDI2+
5	--	LAN_MDI2-
6	RX-	LAN_MDI1-
7	--	LAN_MDI3+
8	--	LAN_MDI3-

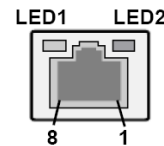

LED1 (Speed)		LED2 (Link/Activity)	
Status	Description	Status	Description
Off	10/100 Mbps connection	Off	No Link
Orange	1 Gbps connection	On	Linked
Green	2.5 Gbps connection	Blinking	Data Activity

4.2 Onboard Headers / Connectors

4.2.1 PS/2 Keyboard/Mouse Header

Pin	Signal	Pin	Signal	Pin	Signal	Pin	Signal
1	KBCLK	3	KBDATA	5	MSDATA	7	MSCLK
2	+5V	4	+5V	6	GND	8	GND



4.2.2 LAN LED Header

Pin	Signal	Pin	Signal	Pin	Signal	Pin	Signal
1	LILEDP	2	LED_LNK#_ACT	3	LED_1000#	4	LED_2500#



4.2.3 ATX12V Power Connector

This motherboard provides an 8-pin ATX 12V power connector. To use a 4-pin ATX power supply, please plug it along Pin 1 and Pin 5.

Pin	Signal	Pin	Signal	Pin	Signal	Pin	Signal
8	ATX12V	7	ATX12V	6	ATX12V	5	ATX12V
4	GND	3	GND	2	GND	1	GND



4.2.4 CPU Fan Connector (+12V)

Please connect the CPU fan cable to the connector and match the black wire to the ground pin.

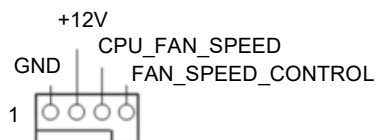

4.2.5 Chassis Fan Connectors (+12V)

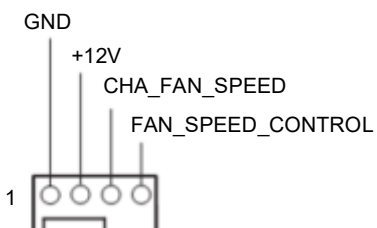

4.2.6 USB 2.0 Connectors

There are two USB 2.0 Type-A vertical connectors on this motherboard.

Pin	Signal
4	GND
3	USB_D+
2	USB_D-
1	USB_PWR

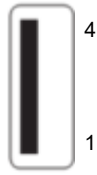

4.2.7 PSU_SMB1

Pin	Signal
1	SMB_CLK
2	SMB_DATA
3	SMBALERT#
4	GND
5	+3V



4.2.8 24-pin ATX Power Input Connector

This motherboard provides a 24-pin ATX power connector. To use a 20-pin ATX power supply, plug it along Pin 1 and Pin 13.

Pin	Signal	Pin	Signal
12	+3V	24	GND
11	+12V	23	+5V
10	+12V	22	+5V
9	ATX+5VSB	21	+5V
8	PWROK_PS	20	NA
7	GND	19	GND
6	+5V	18	GND
5	GND	17	GND
4	+5V	16	PSON#
3	GND	15	GND
2	+3V	14	-12V
1	+3V	13	+3V

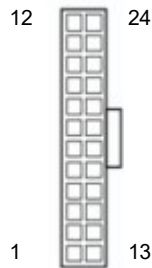

4.2.9 USB 3.2 Gen 1 Header

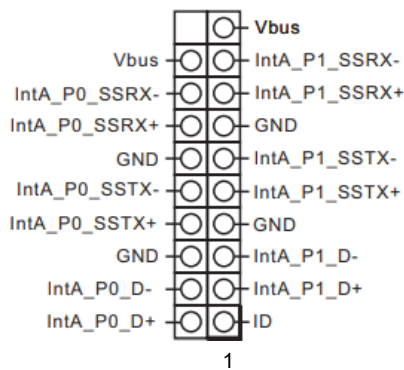

4.2.10 SATA3 Connectors

The Serial ATA3 (SATA3) connectors support SATA data cables for internal storage devices. The current SATA3 interface allows up to 6.0 Gb/s data transfer rate.

Pin	Signal	Pin	Signal
1	GND	5	SATA-B-
2	SATA-A+	6	SATA-B+
3	SATA-A-	7	GND
4	GND		

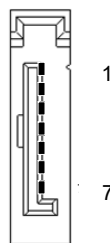

4.2.11 System Panel Header

This header accommodates several system front panel functions.

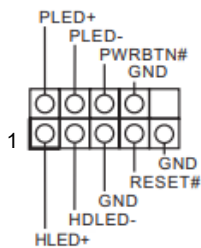

4.2.12 COM Port Header (RS232)

Pin	Signal	Pin	Signal
1	DCD	6	DSR
2	RXD	7	RTS
3	TXD	8	CTS
4	DTR	9	PWR
5	GND		

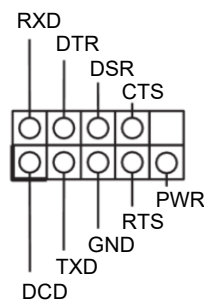

4.2.13 ESP1 Header (ESP1)

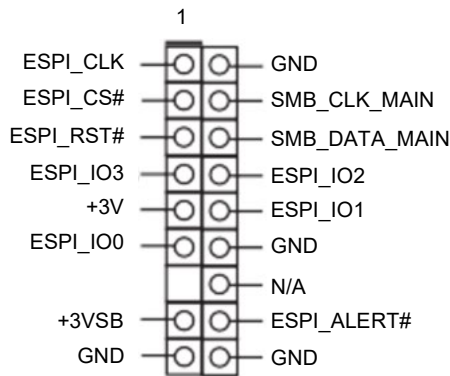

4.2.14 Printer Port / GPIO Header

If you want to use the printer port function, please short pin4 and pin5 on Digital Input / Output Power Select (JGPIO_PWR1).

GPIO

Pin	Signal	Pin	Signal
		25	NA
24	GND	23	SIO_GP70/GPP_E6
22	GND	21	SIO_GP71/GPP_E5
20	GND	19	SIO_GP72/TIME_SYNC1
18	GND	17	SIO_GP87/TIME_SYNC0
16	GND	15	SIO_GP86
14	GND	13	SIO_GP85
12	JGPIO_PWR	11	SIO_GP84
10	JGPIO_PWR	9	SIO_GP83
8	SIO_GP73	7	SIO_GP82
6	SIO_GP74	5	SIO_GP81
4	SIO_GP75	3	SIO_GP80
2	SIO_GP76	1	SIO_GP77

Printer Port

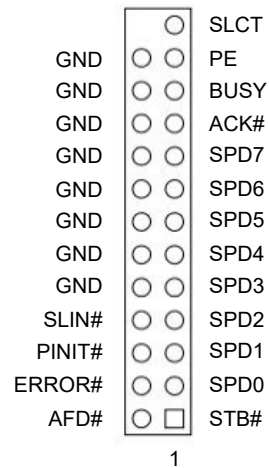

4.2.15 USB 2.0 Header

USB PWR

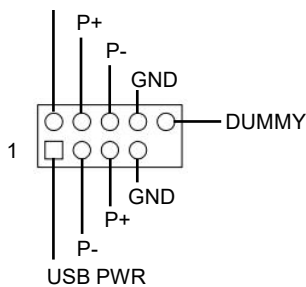

4.2.16 SPDIF Header

SPDIF header, providing SPDIF audio output to HDMI VGA card, allows the system to connect HDMI Digital TV/projector/LCD devices. Please connect the SPDIF connector of HDMI VGA card to this header.

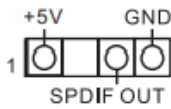

4.2.17 Front Panel Audio Header

This is an interface for front panel audio cable that allows convenient connection and control of audio devices.

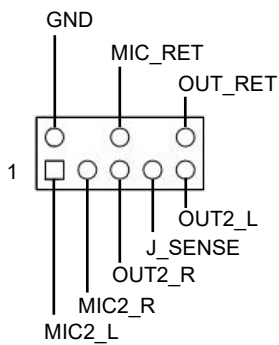

4.2.18 Buzzer Header

Pin	Signal
1	+5V
2	BUZZ_LOW



4.2.19 LAN LED Headers

Pin	Signal
1	LILED_P
2	LED_LNK#_ACT
3	LED_1000#
4	LED_2500#



4.2.20 PCIe Power connector

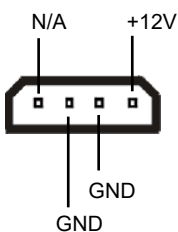

4.3 Jumper and Switch Settings

4.3.1 COM Port Pin9 PWR Setting Jumpers (No.1, 2, 25)

3-pin PWR for COM Port 1, COM Port 2, and COM Port 3~6.

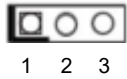

1-2: +5V
2-3: +12V

4.3.2 Chassis Intrusion Headers (No. 10, 13)

This motherboard supports CASE OPEN detection feature that detects if the chassis cover has been removed. This feature requires a chassis with chassis intrusion detection design.

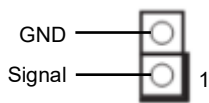

C11:
Short: Active Case Open
Open: Normal
C12:
Short: Normal
Open: Active Case Open

4.3.3 PWR LOSS Header (No. 12)

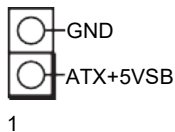

Short: Power Loss
Open: No Power Loss

4.3.4 ATX/AT Mode Jumper (No. 26)



Short: AT Mode
Open: ATX Mode

4.3.5 Digital Input / Output Default Value Setting (No. 29)

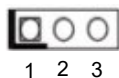

1-2: Pull-High
2-3: Pull-Low

4.3.6 Digital Input / Output Power Select (No. 30)



1-2: +12V
2-3: +5V
3-4: +5V
4-5: GND

4.3.7 Clear CMOS Jumpers (No. 35)

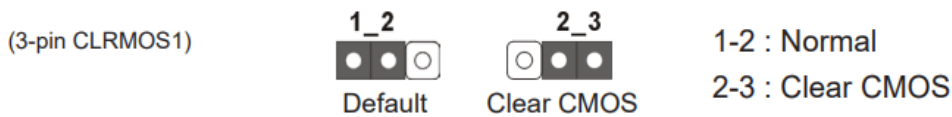

CLRMOS1 allows you to clear the data in CMOS. To clear and reset the system parameters to default setup, please turn off the computer and unplug the power cord from the power supply. After waiting for 15 seconds, use a jumper cap to short pin2 and pin3 on CLRMOS1 for 5 seconds. However, please do not clear the CMOS right after you update the BIOS. If you need to clear the CMOS when you just finish updating the BIOS, you must boot up the system first, and then shut it down before you do the clear-CMOS action. Please be noted that the date, time and user default profile will be cleared only if the CMOS battery is removed.

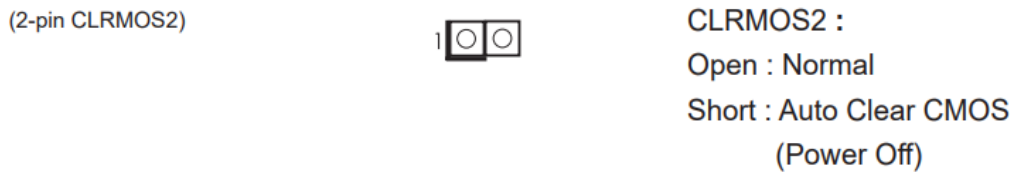

CLRMOS2 allows you to clear the data in CMOS automatically when AC power is on. The data in CMOS includes system setup information such as system password, date, time, and system setup parameters. To clear and reset the system parameters to default setup, please turn off the computer and unplug the power cord, and then use a jumper cap to short the pins on CLRMOS2.

4.3.8 PWR_BAT1 (No. 36)

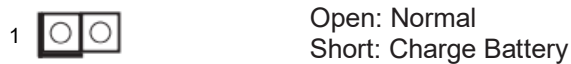

4.3.9 DACC1 (No. 38)

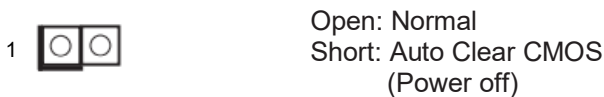

Auto clear CMOS when system boot improperly.

4.4 Expansion Slots

There are 7 PCI Express slots, 3 M.2 sockets, and 1 SIM socket on this motherboard.

PCIe and PCI slots:

	Slot 1 (PCIe1)	Slot 2 (PCIe2)	Slot 3 (PCIe3)	Slot 4 (PCIe4)	Slot 5 (PCIe5)	Slot 6 (PCIe6)	Slot 7 (PCIe7)
Source	CPU	PCH	PCH	CPU	PCH	PCH	PCH
Bandwidth	PCIe 5.0	PCIe 3.0	PCIe 4.0	PCIe 5.0	PCIe 3.0	PCIe 4.0	PCIe 4.0
Lane Config 1	x16	x1	x4	N/A	x1	x4	x4
Lane Config 2	x8			x8			

SIM socket: 1 x SIM socket connected to M.2 key B

M.2 sockets:

- M.2 Key-M (M2_M1)

Pin	Signal	Signal	Pin
1	GND	+3.3V	2
3	GND	+3.3V	4
5	PERn3	NA	6
7	PERp3	NA	8
9	GND	LED	10
11	PETn3	+3.3V	12
13	PETp3	+3.3V	14
15	GND	+3.3V	16
17	PERn2	+3.3V	18
19	PERp2	NA	20
21	GND	NA	22
23	PETn2	NA	24
25	PETp2	NA	26
27	GND	NA	28
29	PERn1	NA	30
31	PERp1	NA	32
33	GND	NA	34
35	PETn1	NA	36
37	PETp1	DEVSLP	38
39	GND	SMB_CLK	40
41	PERn0	SMB_DATA	42
43	PERp0	NA	44
45	GND	NA	46
47	PETn0	NA	48
49	PETp0	PERST#	50
51	GND	CLKREQ#	52
53	PEFCLKn	WAKE#	54
55	PEFCLKp	NA	56
57	GND	NA	58
67	NA	NA	68
69	PEDET	+3.3V	70
71	GND	+3.3V	72
73	GND	+3.3V	74
75	GND		

- M.2 Key-E (M2_E1)

Pin	Signal	Signal	Pin
1	GND	+3VSB	2
3	USB_D+	+3VSB	4
5	USB_D-	NA	6
7	GND	NA	8
9	CNV_WGR_D1-	CNV_RF_RESET	10
11	CNV_WGR_D1+	NA	12
13	GND	MODEM_CLKREQ	14
15	CNV_WGR_D0-	NA	16
17	CNV_WGR_D0+	GND	18
19	GND	NA	20
21	CNV_WGR_CLK-	CNV_BRI_RSP	22
23	CNV_WGR_CLK+		
33	GND	CNV_BGI_DT	32
35	PETp	CNV_RGI_RSP	34
37	PETn	CNV_BRI_DT	36
39	GND	NA	38
41	PERp	NA	40
43	PERn	NA	42
45	GND	NA	44
47	PEFCLKp	NA	46
49	PEFCLKn	NA	48
51	GND	SUSCLK	50
53	CLKREQ#	PERST0#	52
55	WAKE#	W_DISABLE1#	54
57	GND	W_DISABLE2#	56
59	CNV_WT_D1-	SMB_DATA	58
61	CNV_WT_D1+	SMB_CLK	60
63	GND	NA	62
65	CNV_WT_D0-	CLKIN_XTAL_LCP	64
67	CNV_WT_D0+	NA	66
69	GND	NA	68
71	CNV_WT_CLK-	NA	70
73	CNV_WT_CLK+	+3VSB	72
75	GND	+3VSB	74

- M.2 Key-B (M2_B1)

Pin	Signal	Signal	Pin
1	NA	+3.3V	2
3	GND	+3.3V	4
5	GND	FuLL_Card_Power_off	6
7	USB_D+	W_DISABLE	8
9	USB_D-	WWAN_LED#	10
11	GND		
21	GND	NA	20
23	NA	NA	22
25	NA	NA	24
27	GND	NA	26
29	USB3_RX-	NA	28
31	USB3_RX+	UIM_RESET	30
33	GND	UIM_CLK	32
35	USB3_TX-	UIM_DATA	34
37	USB3_TX+	UIM_PWR	36
39	GND	NA	38
41	PERn0	NA	40
43	PERP0	NA	42
45	GND	NA	44
47	PETn0	NA	46
49	PETP0	NA	48
51	GND	PERST#	50
53	PEFCLKn	CLKREQ#	52
55	PEFCLKp	WAKE#	54
57	GND	NA	56
59	NA	NA	58
61	NA	NA	60
63	NA	NA	62
65	NA	NA	64
67	NA	NA	66
69	NA	NA	68
71	GND	+3.3V	70
73	GND	+3.3V	72
75	NA	+3.3V	74

5 Driver Installation

Download the requisite drivers for your system from the IMB-M47-R680E product page at:

https://www.adlinktech.com/Products/Industrial_Motherboards_SBCs/ATXMotherboards/IMB-M47-R680E

This page intentionally left blank.

6 UEFI Setup

6.1 Menu Structure

This section presents the primary menus of the UEFI Setup Utility. Use the following table as a quick reference for the contents of the UEFI Setup Utility. The subsections describe the submenus and options for each menu item.

2 Options to enter UEFI Setup Utility:

- Press [F2] or [Del] during POST (Power-On-Self-Test)
- Press [Ctl] + [Alt] + [Del] after POST

Main	Advanced	H/W Monitor
Sets up the system time/date and displays the system information: - System Date - System Time	Contains advanced system configurations, including: - CPU Configuration - Chipset Configuration - Storage Configuration - Super IO Configuration - AMT Configuration - ACPI Configuration - USB Configuration - Trusted Computing - Instant Flash	Displays Hardware Status info, including: - CPU_FAN1 Setting - CHA_FAN1 Setting - CHA_FAN2 Setting - CHA_FAN3 Setting - Case Open Feature
Security	Boot	Exit
Changes or clears the supervisor/user password for the system - Supervisor Password - User Password - Secure Boot	Configures the boot settings and boot priority for available devices - Boot Option #1 - Boot From Onboard LAN - Setup Prompt Timeout - Bootup Num-Lock - Full Screen Logo	Exits the UEFI Setup Utility while saving or discard the changes made - Save Changes and Exit - Discard Changes and Exit - Discard Changes - Load UEFI Defaults - Launch EFI Shell from filesystem device

6.2 Main Menu

Upon entering the UEFI Setup Utility, the Main Menu is displayed, providing read-only information about your system and also allows you to set the System Date and Time. Refer to the screenshots and tables below for details of the submenus and settings.

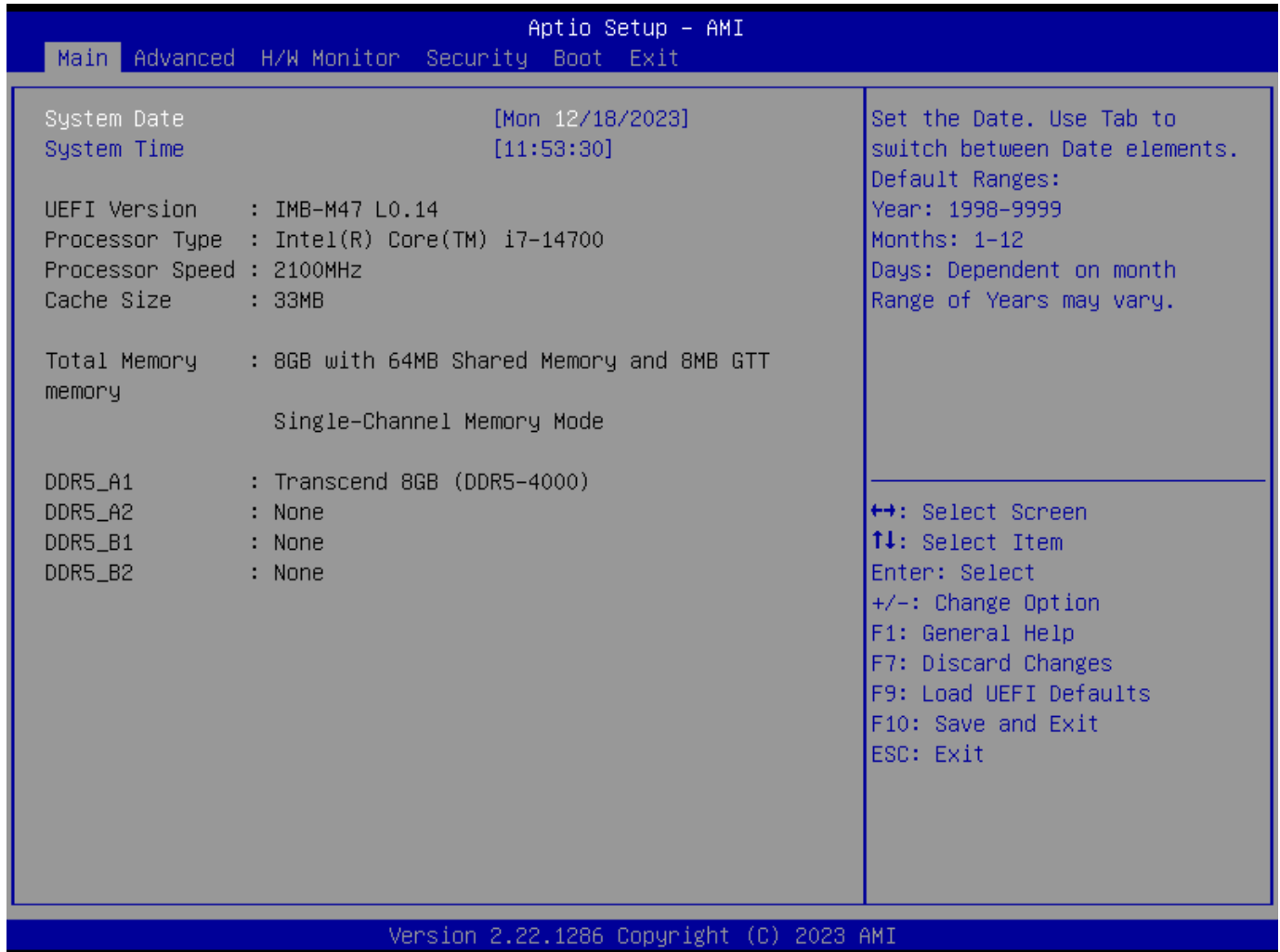

The screenshot displays the 'Aptio Setup - AMI' utility. At the top, a navigation bar includes 'Main', 'Advanced', 'H/W Monitor', 'Security', 'Boot', and 'Exit'. The 'Main' menu is active, showing the following system information:

- System Date: [Mon 12/18/2023]
- System Time: [11:53:30]
- UEFI Version: IMB-M47 L0.14
- Processor Type: Intel(R) Core(TM) i7-14700
- Processor Speed: 2100MHz
- Cache Size: 33MB
- Total Memory: 8GB with 64MB Shared Memory and 8MB GTT memory
- Single-Channel Memory Mode
- DDR5_A1: Transcend 8GB (DDR5-4000)
- DDR5_A2: None
- DDR5_B1: None
- DDR5_B2: None

On the right side, instructions for setting the date and time are provided:

Set the Date. Use Tab to switch between Date elements.
 Default Ranges:
 Year: 1998-9999
 Months: 1-12
 Days: Dependent on month
 Range of Years may vary.

Navigation instructions are listed at the bottom right:

- ←→: Select Screen
- ↑↓: Select Item
- Enter: Select
- +/-: Change Option
- F1: General Help
- F7: Discard Changes
- F9: Load UEFI Defaults
- F10: Save and Exit
- ESC: Exit

At the bottom of the screen, the version and copyright information are displayed: 'Version 2.22.1286 Copyright (C) 2023 AMI'.

6.3 Advanced Menu

Contains the configurations for the following: CPU Configuration, Chipset Configuration, Storage Configuration, Super IO Configuration, AMT Configuration, ACPI Configuration, USB Configuration, and Trusted Computing.

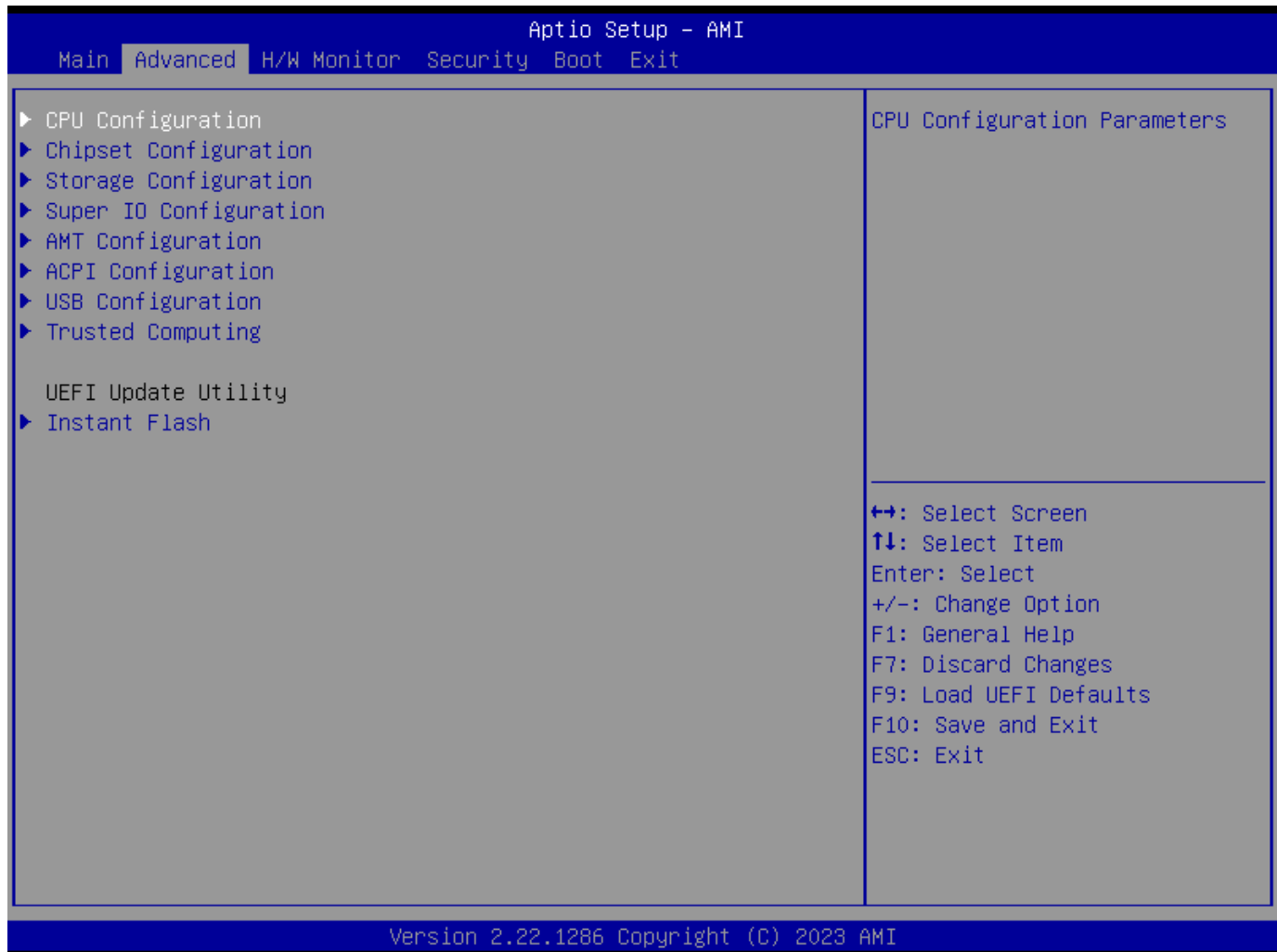

Feature	Description
Instant Flash	Instant Flash is a UEFI flash utility embedded in Flash ROM. This convenient UEFI update tool allows you to update system UEFI without entering operating systems first like MS-DOS or Windows®. Just launch this tool and save the new UEFI file to your USB flash drive, floppy disk or hard drive, and then you can update your UEFI in only a few clicks without preparing an additional floppy diskette or other complicated flash utility. Please be noted that the USB flash drive or hard drive must use FAT32/16/12 file system. If you execute Instant Flash utility, the utility will show the UEFI files and their respective information. Select the proper UEFI file to update your UEFI, and reboot your system after UEFI update process completes.

6.3.1 Advanced > CPU Configuration

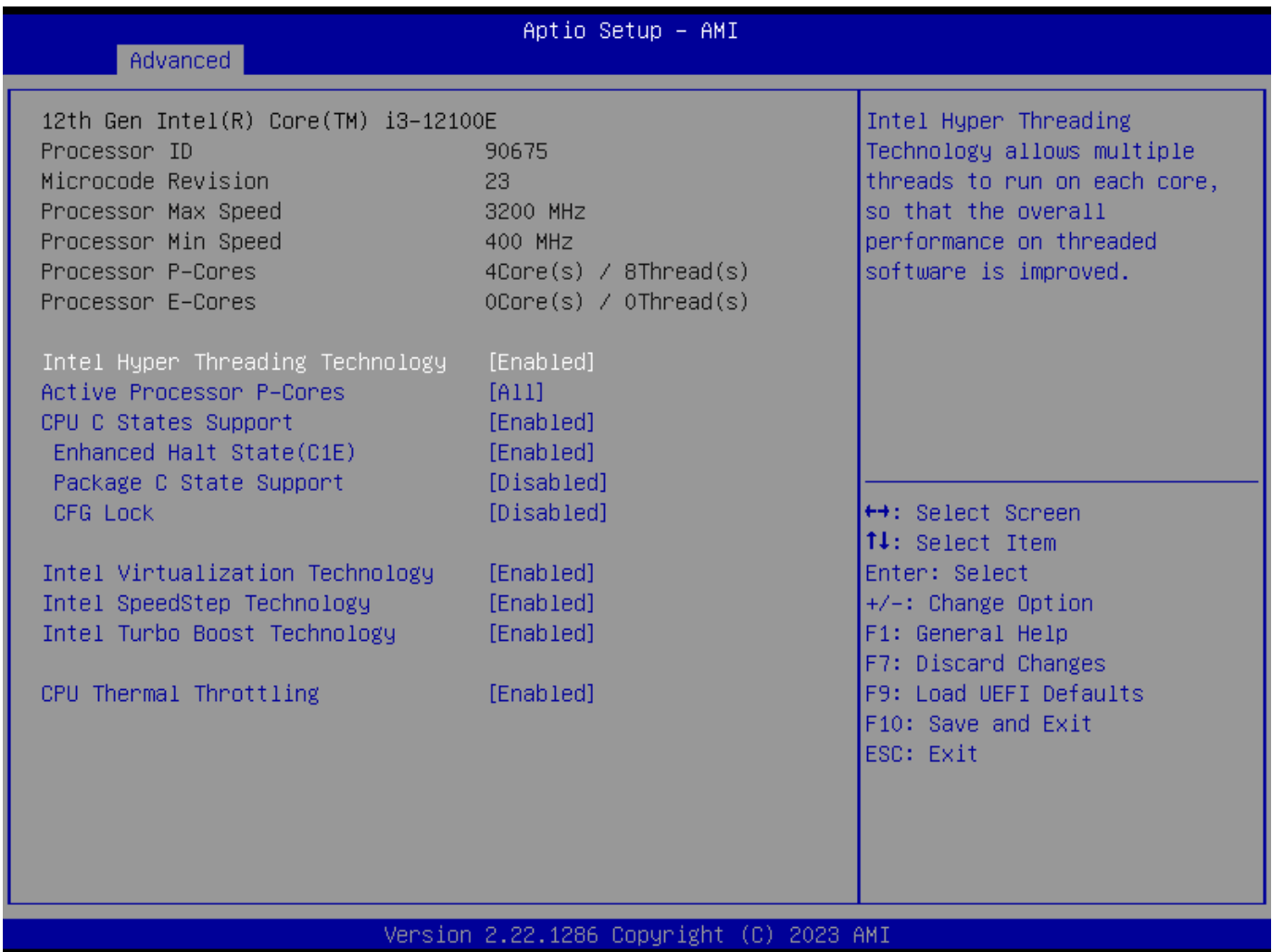

Feature	Description
Intel Hyper Threading Technology	Intel Hyper Threading Technology allows multiple threads to run on each core, so that the overall performance on threaded software is improved. Configuration options: [Enabled] [Disabled]
Active Processor P-Cores	This allows you to select the number of cores to enable in each processor package.
Active Processor E-Cores	This allows you to select the number of E-Cores to enable in each processor package. NOTE: Number of P-Cores and E-Cores are looked at together. When both are {0,0}, Pcode will enable all cores.
CPU C States Support	This allows you to enable CPU C States Support for power saving. It is recommended to keep C3, C6 and C7 all enabled for better power saving. Configuration options: [Enabled] [Disabled]
Enhanced Halt State (C1E)	The option allows you to enable Enhanced Halt State (C1E) for lower power consumption. Configuration options: [Enabled] [Disabled]
Package C State Support	The option allows you to enable CPU, PCIe, Memory, Graphics C State Support for power saving.
CFG Lock	The option allows you to enable or disable the CFG Lock. Configuration options: [Enabled] [Disabled]

Feature	Description
Intel Virtualization Technology	<p>Intel Virtualization Technology allows a platform to run multiple operating systems and applications in independent partitions, so that one computer system can function as multiple virtual systems.</p> <p>Configuration options: [Enabled] [Disabled]</p>
Intel SpeedStep Technology	<p>Intel SpeedStep technology allows processors to switch between multiple frequencies and voltage points for better power saving and heat dissipation. CPU turbo ratio can be fixed when Intel SpeedStep Technology is set to [Disabled] and Intel Turbo Boost Technology is set to [Enabled].</p> <p>Configuration options: [Enabled] [Disabled].</p> <p>If you install Windows® 10 and want to enable this function, please set this item to [Enabled]. This item will be hidden if the current CPU does not support Intel SpeedStep technology.</p>
Intel Turbo Boost Technology	<p>Intel Turbo Boost Technology enables the processor to run above its base operating frequency when the operating system requests the highest performance state. The default value is [Enabled].</p> <p>Configuration options: [Enabled] [Disabled]</p>
CPU Thermal Throttling	<p>CPU Thermal Throttling allows you to enable CPU internal thermal control mechanisms to keep the CPU from overheating.</p> <p>Configuration options: [Enabled] [Disabled]</p>

6.3.2 Advanced > Chipset Configuration

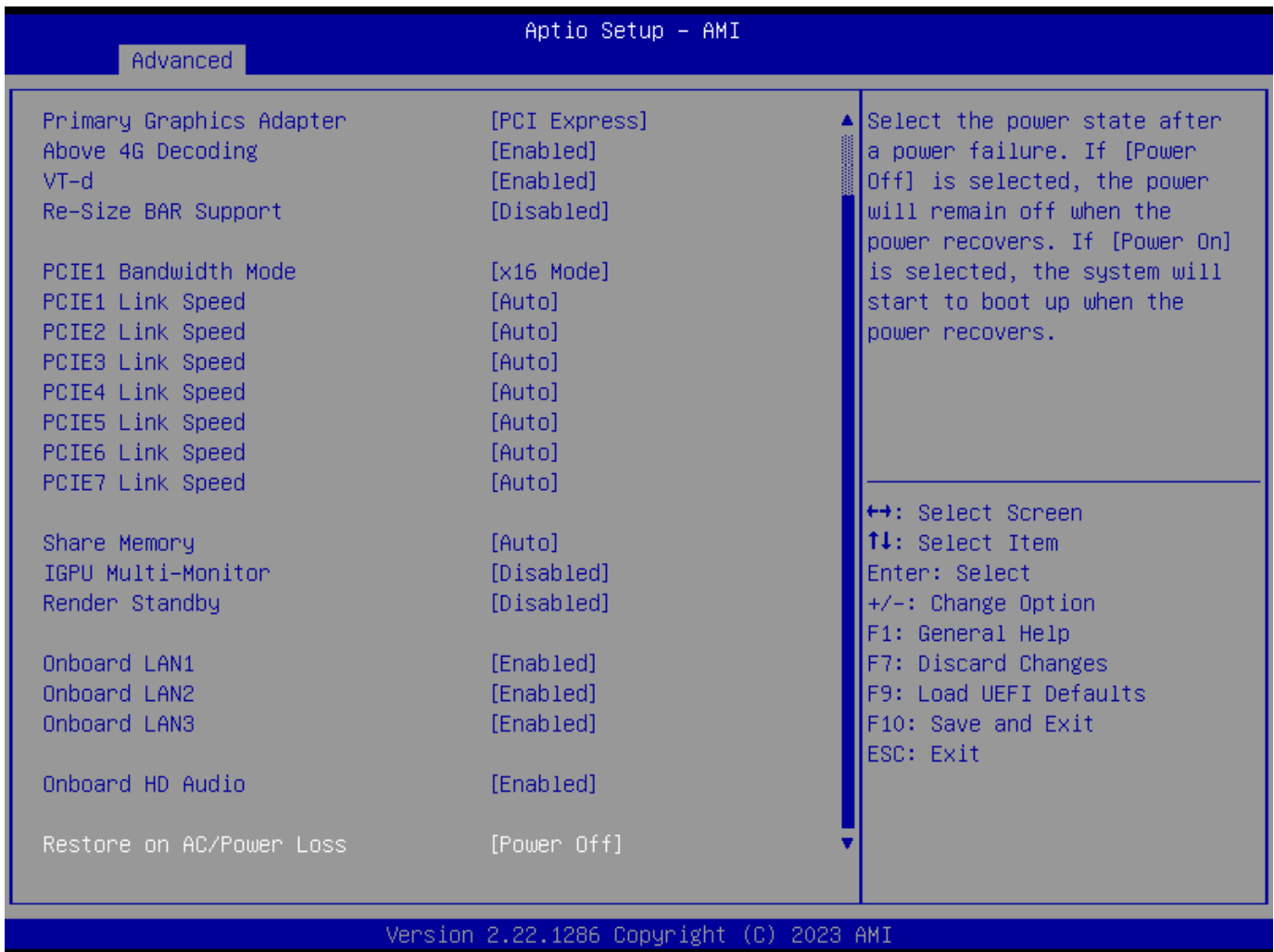

Feature	Description
Primary Graphics Adapter	The option allows you to select a primary VGA. Configuration options: [Onboard] [PCI Express] (Options vary when you have installed a graphics card on your motherboard.)
Above 4G Decoding	The option allows you to enable or disable above 4G Memory Mapped IO decoding. This is disabled automatically when Aperture Size is set to 2048MB. Configuration options: [Enabled] [Disabled]
VT-d	Intel® Virtualization Technology for Directed I/O helps your virtual machine monitor better utilize hardware by improving application compatibility and reliability, and providing additional levels of manageability, security, isolation, and I/O performance. Configuration options: [Enabled] [Disabled]
Re-Size BAR Support	If system has Resizable BAR capable PCIe Devices, this option enables or disables Resizable BAR Support.
PCIE1 Bandwidth Mode	Select PCIE1 Bandwidth. Select [PCIE4] when using PCIE4 slot. Select [x8 / x8 Mode] when using Riser card on PCIE1 slot. (PCIE4 slot will be disabled)
PCIE1 Link Speed	The option allows you to configure PCIE1 Slot Link Speed. Auto mode is optimizing for overclocking. Configuration options: [Auto] [Gen1] [Gen2] [Gen3] [Gen4] [Gen5] (Options vary depending on your motherboard.)

Feature	Description
PCIe2 Link Speed	The option allows you to configure PCIe2 Slot Link Speed. Auto mode is optimizing for overclocking. Configuration options: [Auto] [Gen1] [Gen2] [Gen3] (Options vary depending on your motherboard.)
PCIe3 Link Speed	The option allows you to configure PCIe3 Slot Link Speed. Auto mode is optimizing for overclocking. Configuration options: [Auto] [Gen1] [Gen2] [Gen3] (Options vary depending on your motherboard.)
PCIe4 Link Speed	The option allows you to configure PCIe4 Slot Link Speed. Auto mode is optimizing for overclocking. Configuration options: [Auto] [Gen1] [Gen2] [Gen3] [Gen4] [Gen5] (Options vary depending on your motherboard.)
PCIe5 Link Speed	The option allows you to configure PCIe5 Slot Link Speed. Auto mode is optimizing for overclocking. Configuration options: [Auto] [Gen1] [Gen2] [Gen3] [Gen4] (Options vary depending on your motherboard.)
PCIe6 Link Speed	The option allows you to configure PCIe6 Slot Link Speed. Auto mode is optimizing for overclocking. Configuration options: [Auto] [Gen1] [Gen2] [Gen3] (Options vary depending on your motherboard.)
PCIe7 Link Speed	The option allows you to configure PCIe7 Slot Link Speed. Auto mode is optimizing for overclocking. Configuration options: [Auto] [Gen1] [Gen2] [Gen3] [Gen4] (Options vary depending on your motherboard.)
Share Memory	Share memory allows you to configure the size of memory that is allocated to the integrated graphics processor when the system boots up. Configuration options: [Auto] [32 M] [64 M] [128M] [256M] [512 M] Options vary depending on the memory you use on your motherboard.
IGPU Multi-Monitor	Select [Disabled] to disable the integrated graphics when an external graphics card is installed. Select [Enabled] to keep the integrated graphics enabled at all times. Configuration options: [Enabled] [Disabled]
Render Standby	Power down the render unit when the GPU is idle for lower power consumption.
Onboard LAN (1,2,3)	Enables the Onboard LAN1,2,3 features
Onboard HD Audio	Onboard HD Audio allows you to enable or disable the onboard HD audio controller. Set this item to [Auto] to enable the onboard HD and automatically disable it when a sound card is installed. Configuration options: [Enabled] [Disabled]
Restore on AC/Power Loss	The option allows you to select the power state after a power failure. [Power Off] sets the power to remain off when the power recovers. [Power On] sets the system to start to boot up when the power recovers.

6.3.3 Advanced > Storage Configuration

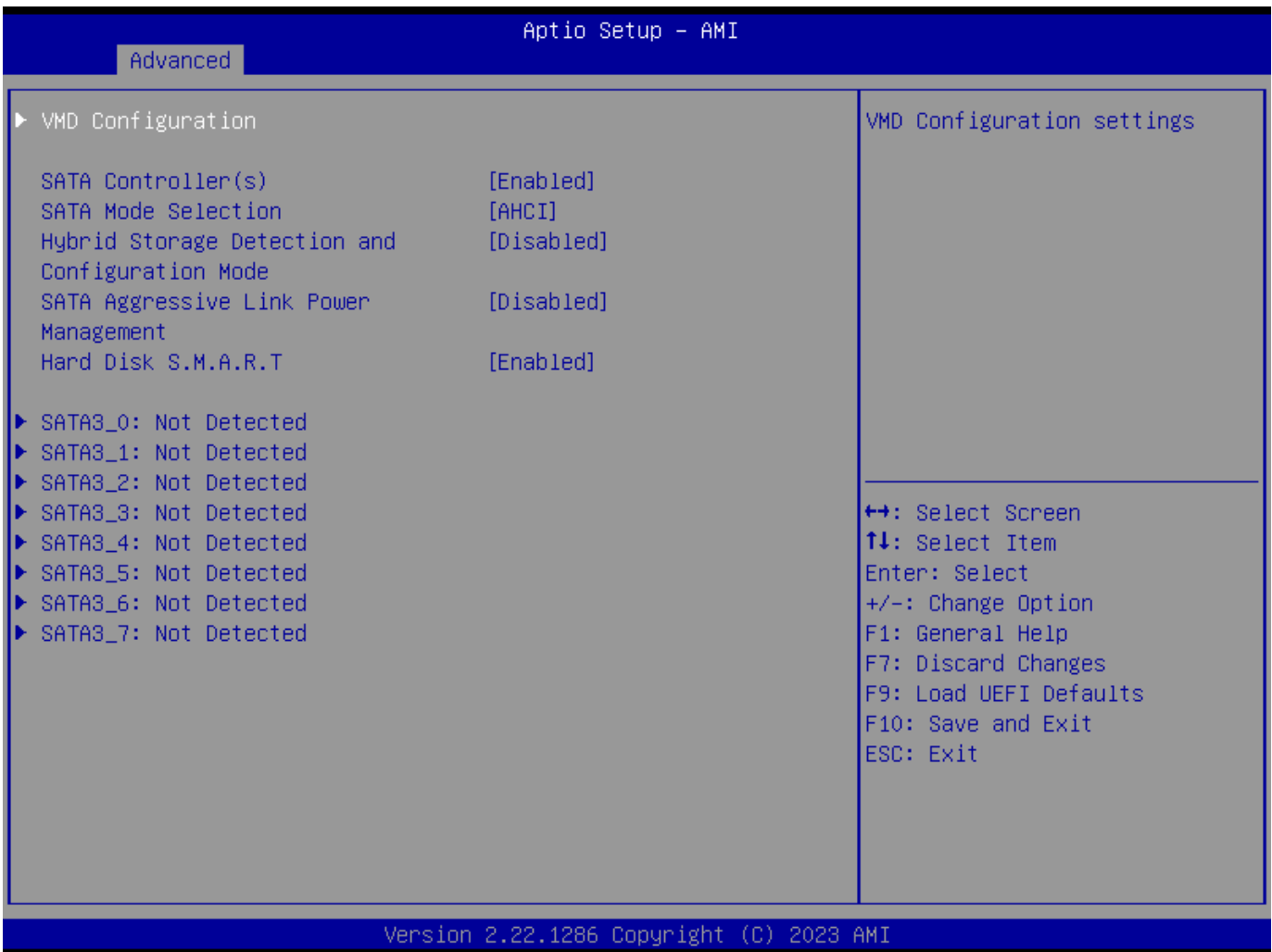

Feature	Description
VMD Configuration	This item allows you to enable or disable the Intel VMD support function.
SATA Controller(s)	The option allows you to enable or disable the SATA controllers. Configuration options: [Enabled] [Disabled]
SATA Mode Selection	AHCI supports new features that improve performance. Configuration option: [AHCI]
Hybrid Storage Detection and Configuration Mode	The option allows you to select Hybrid Storage Detection and Configuration Mode. Configuration options: [Dynamic Configuration for Hybrid Storage Enable] [Disabled]
SATA Aggressive Link Power Management	SATA Aggressive Link Power Management allows SATA devices to enter a low power state during periods of inactivity to save power. It is supported only by AHCI mode. Configuration options: [Enabled] [Disabled]
Hard Disk S.M.A.R.T.	S.M.A.R.T stands for Self-Monitoring, Analysis, and Reporting Technology. It is a monitoring system for computer hard disk drives to detect and report on various indicators of reliability. Configuration options: [Enabled] [Disabled]

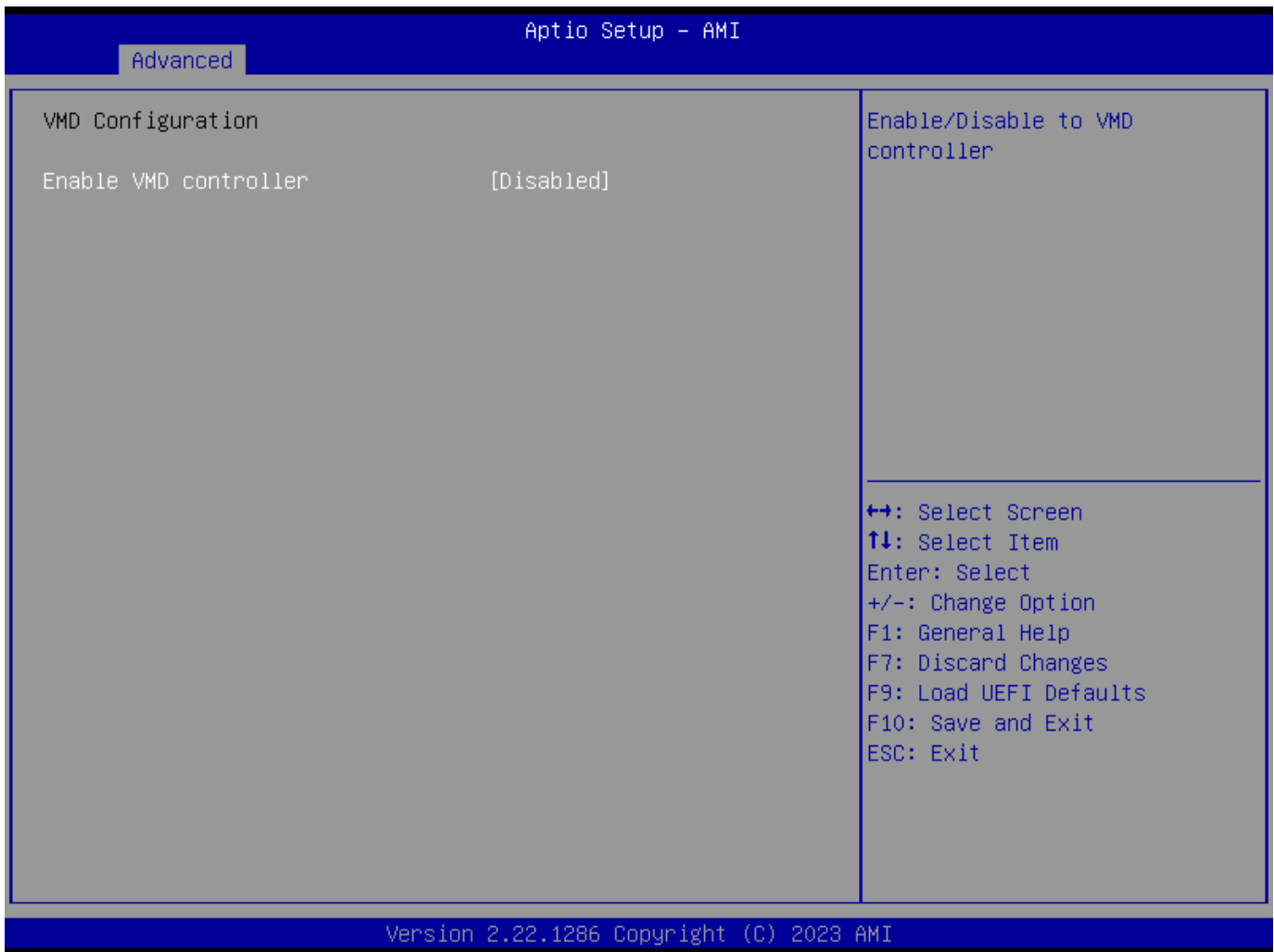

Feature	Description
Enable VMD Controller	Allows you to enable or disable the Intel VMD controller. This following items appear when it is set to [Enabled].

6.3.4 Advanced > Super IO Configuration

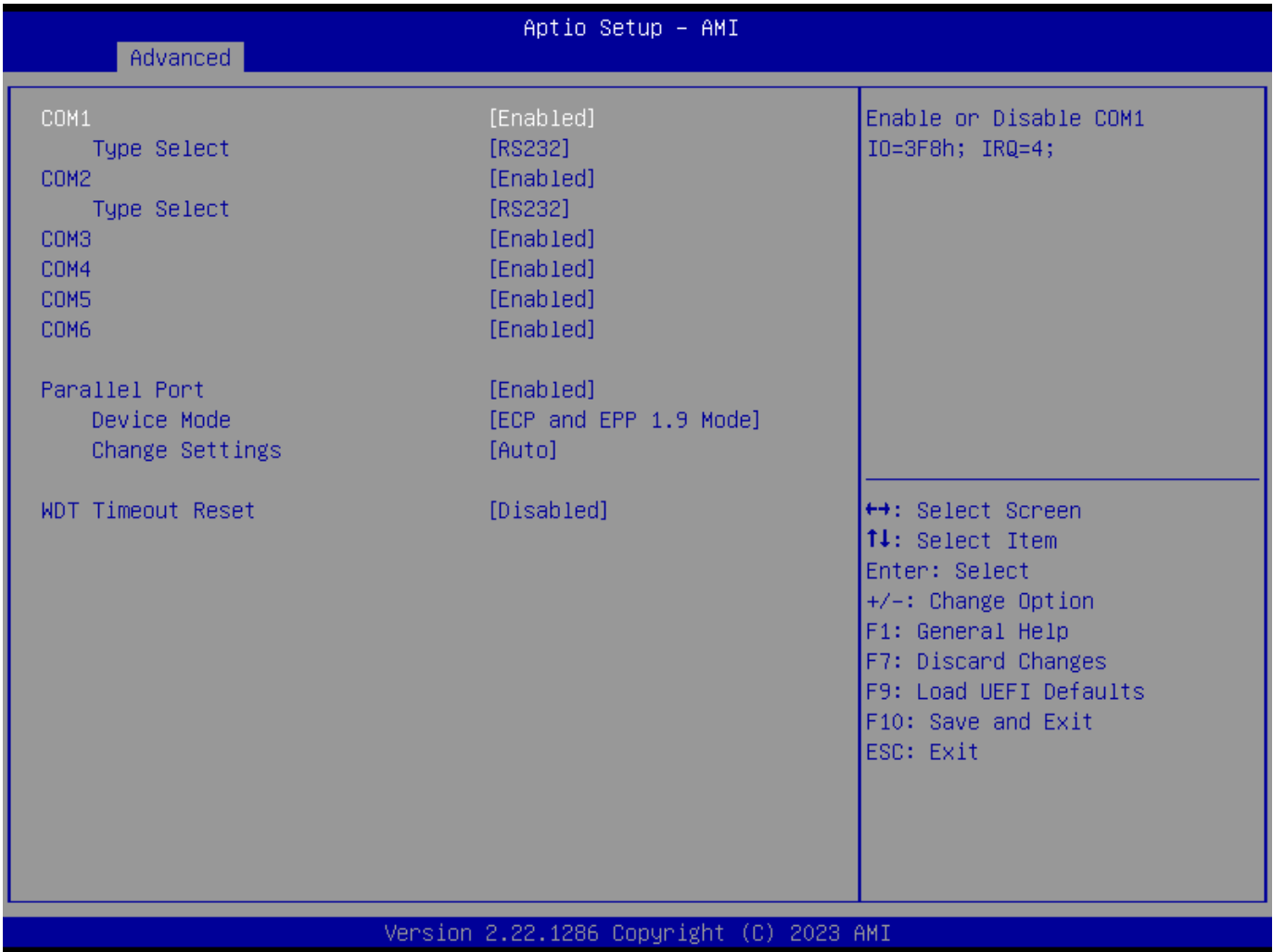

Feature	Description
COM1 Configuration	Use this to set parameters of COM1.
Type Select	Use this to select COM1 port type: [RS232], [RS422] or [RS485].
COM2 Configuration	Use this to set parameters of COM2.
Type Select	Use this to select COM2 port type: [RS232], [RS422] or [RS485].
COM3 Configuration	Use this to set parameters of COM3.
COM4 Configuration	Use this to set parameters of COM4.
COM5 Configuration	Use this to set parameters of COM5.
COM6 Configuration	Use this to set parameters of COM6.
Parallel Port	The option enables or disables the Parallel port.
Device Mode	Selects the device mode according to your connected device.
Change Settings	Select the address of the Parallel port.
WDT Timeout Reset	Use this to set the Watch Dog Timer.

6.3.5 Advanced > AMT Technology



Feature	Description
USB Provisioning of AMT	Use this to enable or disable AMT USB Provisioning. The default is [Disabled].
MAC Pass Through	The option enables or disables MAC Pass Through function.
Activate Remote Assistance Process	Trigger CIRA boot. The default is [Disabled].
Un-Configure ME	Un-Configure ME without password. The default is [Disabled].
ASF Configuration	The option allows you to configure Alert Standard Format parameters.
Secure Erase Configuration	Secure Erase configuration menu.
One Click Recovery(OCR) Configuration	Configuration setting for One Click Recovery. This allows access for AMT to boot a recovery OS application
MEBx	This Formset contains forms for configuring MEBx.

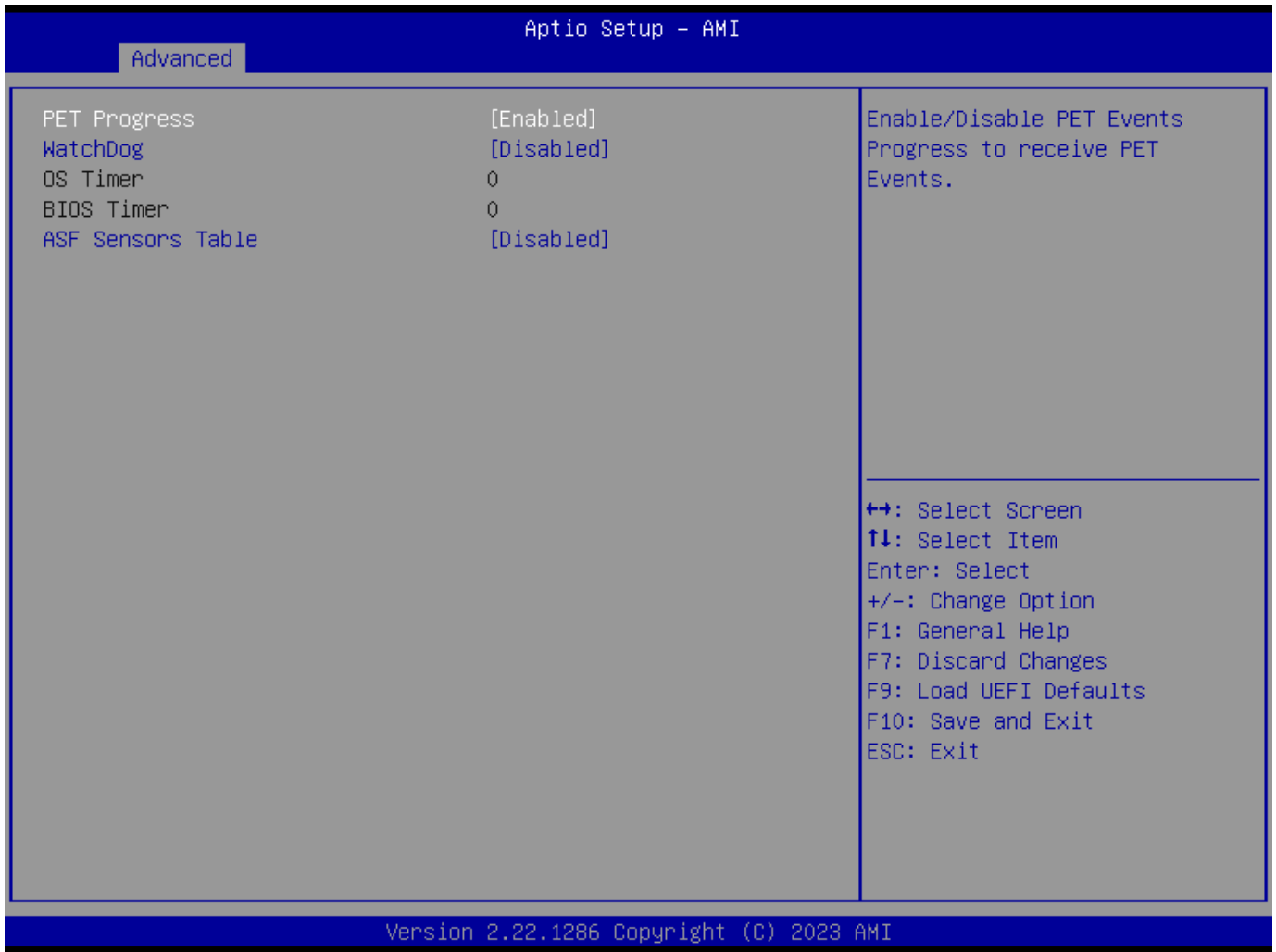

Feature	Description
PET Progress	User can enable or disable PET Events progress to receive PET events or not. The default is [Enabled].
WatchDog	Use this to enable or disable AMT WatchDog Timer. The default is [Disabled].
ASF Sensors Table	Use this to enable or disable ASF Sensor Table. The default is [Disabled].

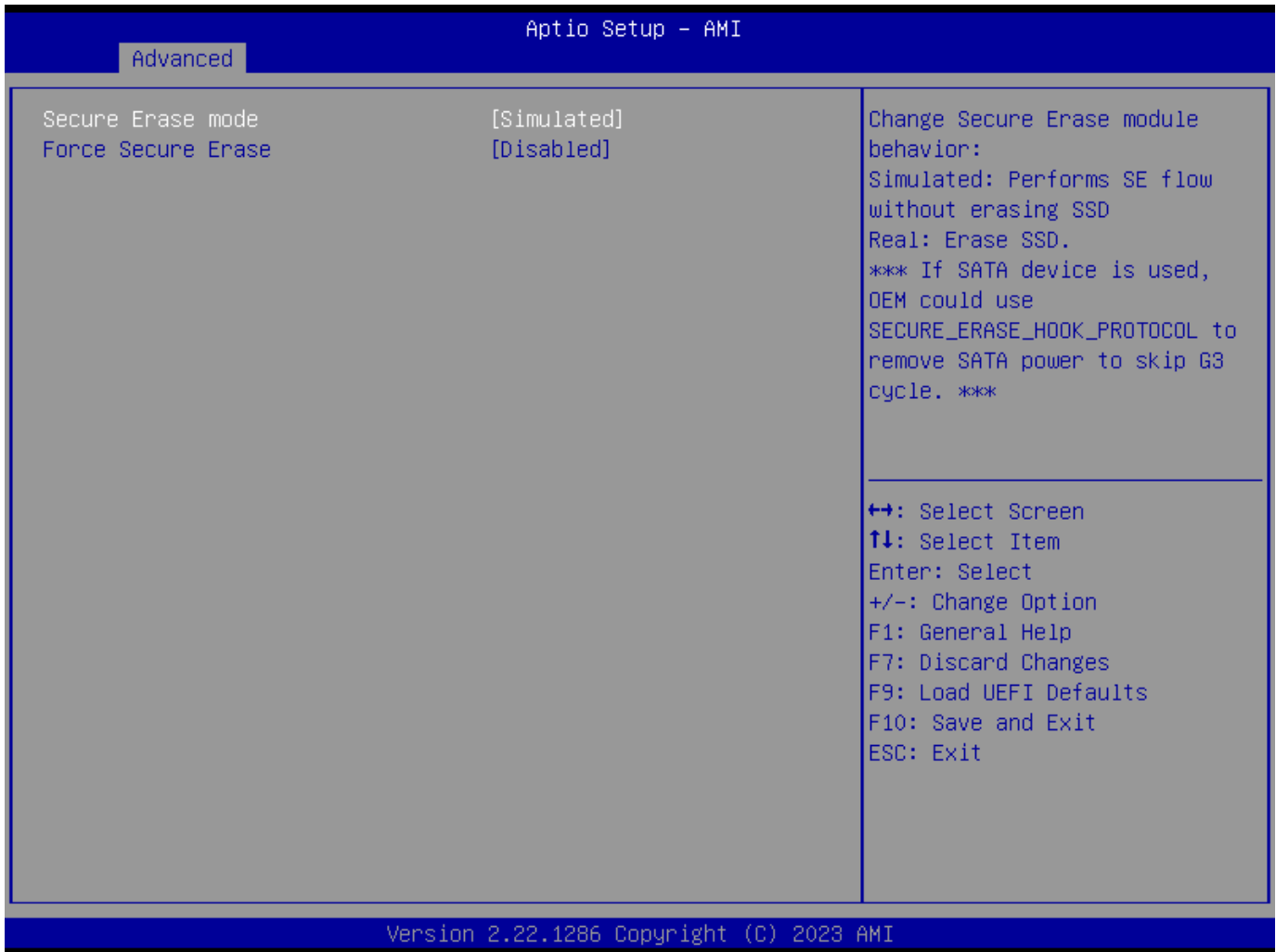

Feature	Description
Secure Erase mode	Change Secure Erase module behavior: Simulated: Performs SE flow without erasing SSD. Real: Erase SSD.
Force Secure Erase	Use this to enable or disable Force Secure Erase on next boot. The default is [Disabled].

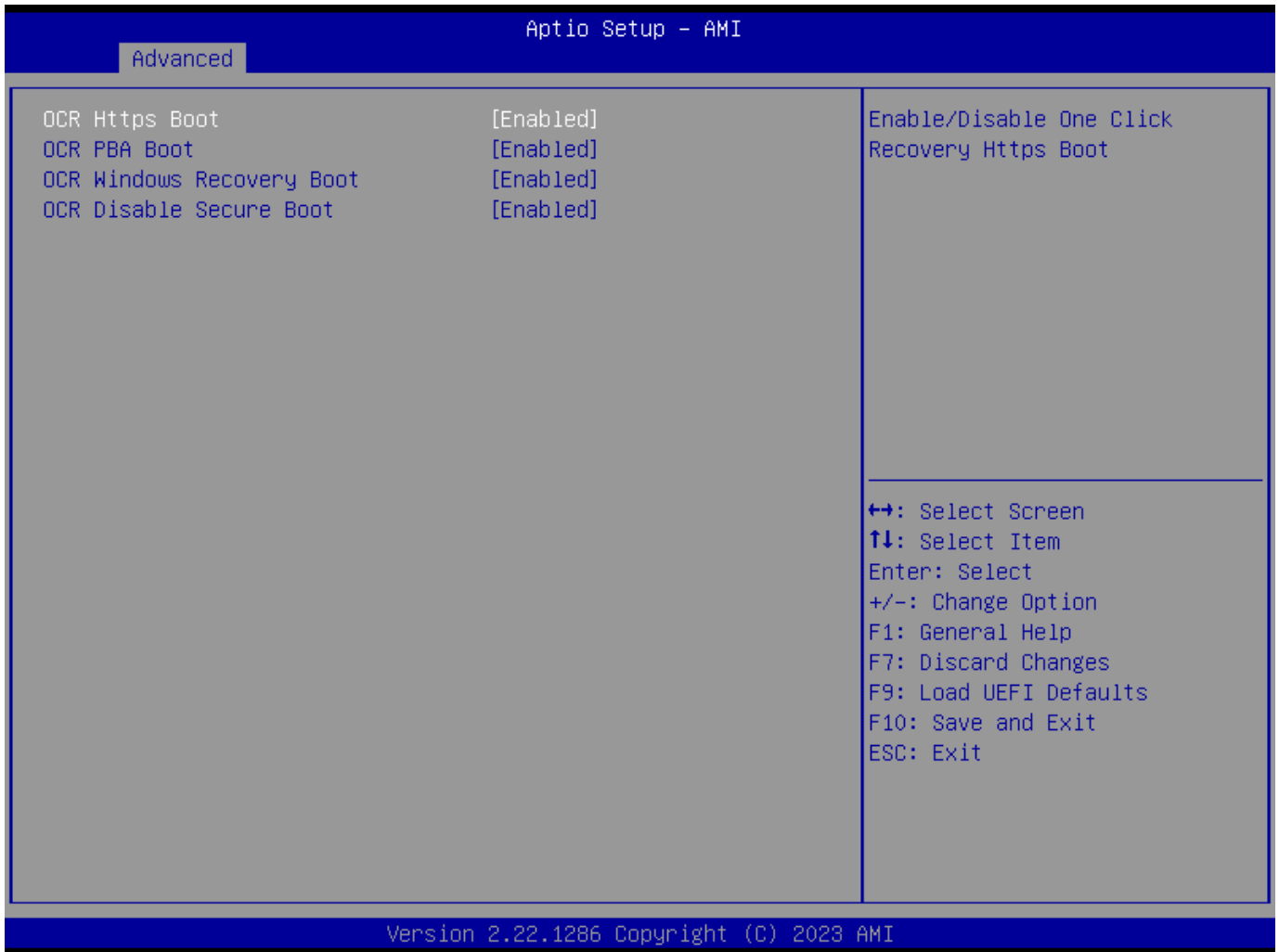

Feature	Description
OCR Http Boot	Use this to enable or disable One Click Recovery Https Boot. The default is [Enabled].
OCR PBA Boot	Use this to enable or disable One Click Recovery PBA Boot. The default is [Enabled].
OCR Windows Recovery Boot	Use this to enable or disable One Click Recovery Windows Recovery Boot. The default is [Enabled].
OCR Disable Secure Boot	Use this to allow CSME to request Secure Boot to be disabled for One Click Recovery. The default is [Enabled].

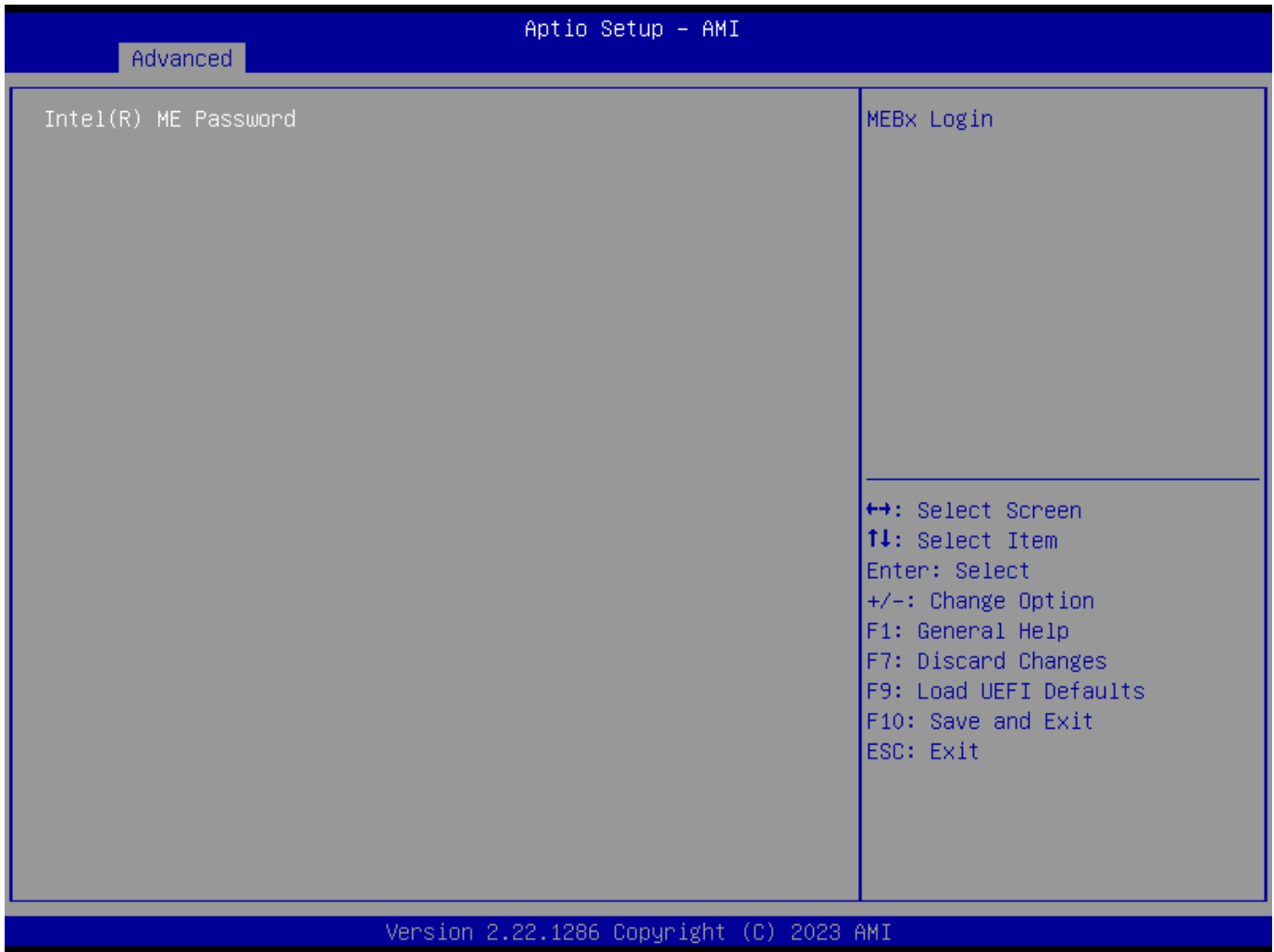

Feature	Description
Intel(R) ME Password	MEBx Login

6.3.6 Advanced > ACPI Configuration

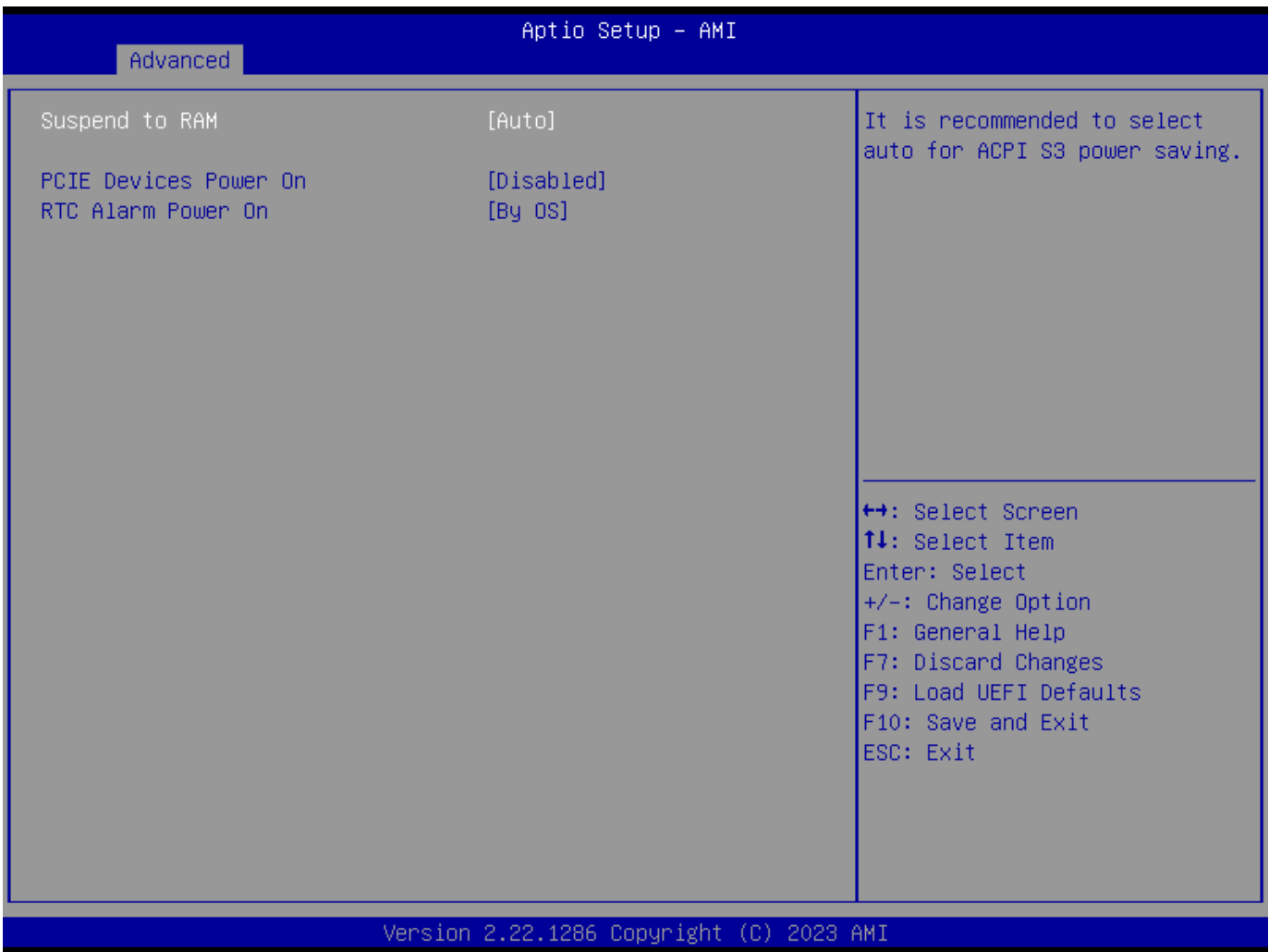

Feature	Description
Suspend to RAM	Suspend to RAM allows you to select [Disabled] for ACPI suspend type S1. It is recommended to select [Auto] for ACPI S3 power saving. Configuration options: [Auto] [Disabled]
PCIE Devices Power On	Use this item to enable or disable PCIE devices to turn on the system from the power-soft-off mode.
RTC Alarm Power On	RTC Alarm Power On allows the system to be waked up by the real time clock alarm. Set it to By OS to let it be handled by your operating system. Configuration options: [Enabled] [Disabled] [By OS]

6.3.7 Advanced > USB Configuration

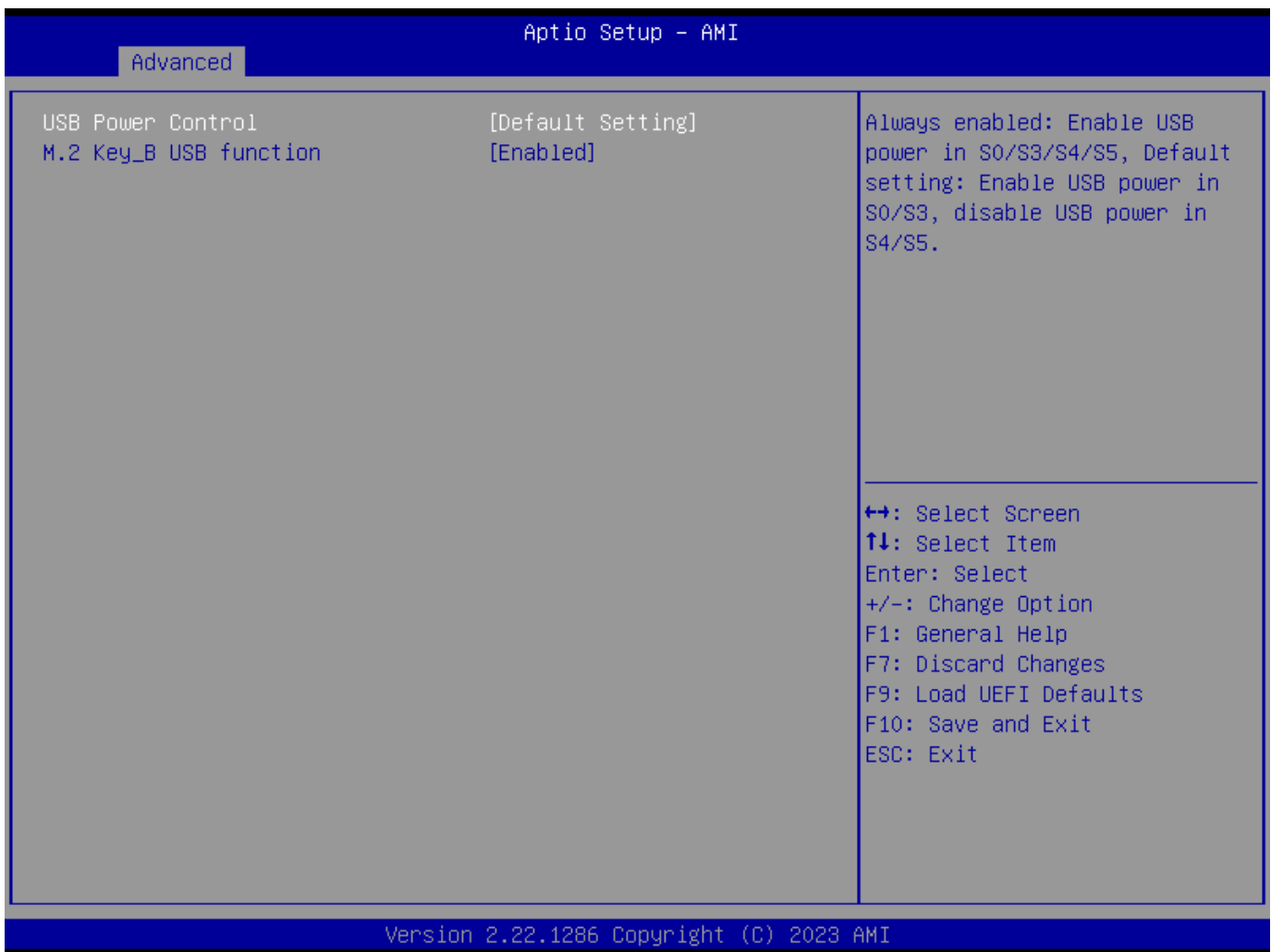

Feature	Description
USB Support	Use this option to control USB power.
M.2 Key_B Function	The item enables or disables M.2 Key_B USB function.

6.3.8 Advanced > Trusted Computing

Advanced
Aptio Setup - AMI

<pre> TPM 2.0 Device Found Firmware Version: 7.85 Vendor: IFX Security Device Support [Enable] Active PCR banks SHA256 Available PCR banks SHA256 SHA256 PCR Bank [Enabled] Pending operation [None] Platform Hierarchy [Enabled] Storage Hierarchy [Enabled] Endorsement Hierarchy [Enabled] Physical Presence Spec Version [1.3] TPM 2.0 InterfaceType [TIS] Device Select [Auto] Onboard TPM [Enabled] </pre>	<pre> Enables or Disables BIOS support for security device. O.S. will not show Security Device. TCG EFI protocol and INT1A interface will not be available. ↔: Select Screen ↑↓: Select Item Enter: Select +/-: Change Option F1: General Help F7: Discard Changes F9: Load UEFI Defaults F10: Save and Exit ESC: Exit </pre>
--	--

Version 2.22.1286 Copyright (C) 2023 AMI

Feature	Description
Security Device Support	Security Device Support allows you to enable or disable BIOS support for security device. O.S. will not show Security Device. TCG EFI protocol and INT1A interface will not be available. Configuration options: [Enabled] [Disabled]
Active PCR banks	This item displays active PCR Banks.
Available PCR Banks	This item displays available PCR Banks.
SHA256 PCR Bank	SHA256 PCR Bank allows you to enable or disable SHA256 PCR Bank. Configuration options: [Enabled] [Disabled]
Pending Operation	Pending Operation allows you to schedule an Operation for the Security Device. NOTE: Your computer will reboot during restart in order to change State of the Device. Configuration options: [None] [TPM Clear]
Platform Hierarchy	This item allows you to enable or disable Platform Hierarchy. Configuration options: [Enabled] [Disabled]
Storage Hierarchy	This item allows you to enable or disable Storage Hierarchy. Configuration options: [Enabled] [Disabled]
Endorsement Hierarchy	This item allows you to enable or disable Endorsement Hierarchy. Configuration options: [Enabled] [Disabled]

Feature	Description
Physical Presence Spec Version	Select this item to tell OS to support PPI spec version 1.2 or 1.3. Please note that some HCK tests might not support version 1.3. Configuration options: [1.2] [1.3]
TPM 2.0 Interface Type	This item allows you to view the Communication Interface to TPM 2.0 Device: CRB or ITS.
Device Select	This item allows you to select the TPM device to be supported. [TPM 1.2] restricts support to TPM 1.2 devices. [TPM 2.0] restricts support to TPM 2.0 devices. [Auto] supports both TPM 1.2 and TPM 2.0 devices with the default set to TPM 2.0 devices. If TPM 2.0 devices are not found, TPM 1.2 devices will be enumerated.
Onboard TPM	The option enables or disables Intel PTT in ME. Disable this option to use discrete TPM Module.

6.4 Hardware Health Event Monitoring Screen

This screen allows you to monitor the status of your system and installed devices, such as CPU temperature, motherboard temperature, CPU fan speed, chassis fan speed, and the critical voltage.

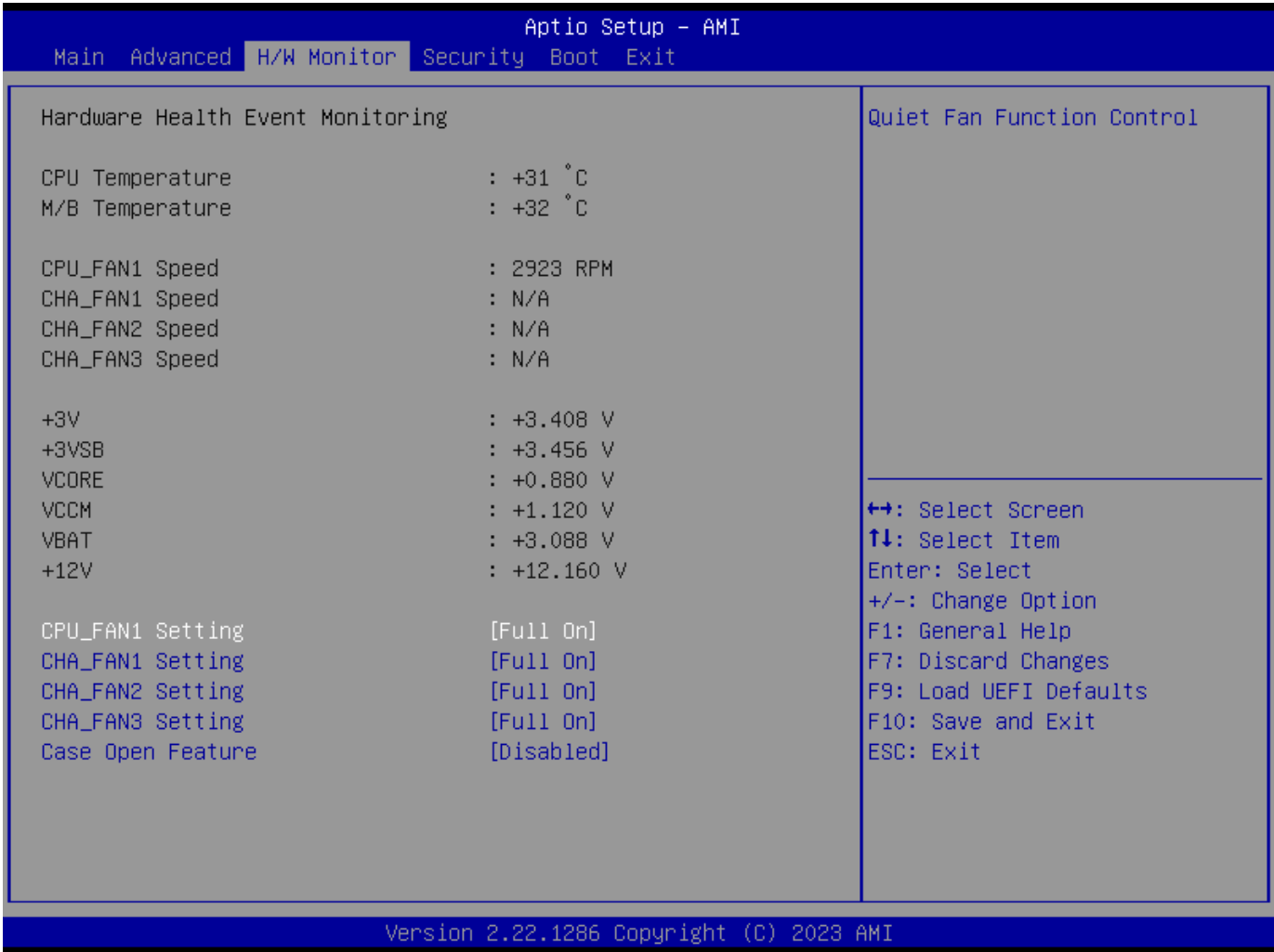

Feature	Description
CPU_Fan 1 Setting	This item allows you to select a fan mode for CPU Fan 1. The default value is [Full On]. Configuration options: [Full On] [Automatic Mode]
CHA_Fan 1 Setting	This allows you to set chassis fan 1's speed. The default value is [Full On]. Configuration options: [Full On] [Automatic Mode]
CHA_Fan 2 Setting	This allows you to set chassis fan 2's speed. The default value is [Full On]. Configuration options: [Full On] [Manual]
CHA_Fan 3 Setting	This allows you to set chassis fan 3's speed. The default value is [Full On]. Configuration options: [Full On] [Manual]
Case Open Feature	This item allows you to enable or disable case open detection feature. The default is value [Disabled].
Clear Status	This option appears only when the case open has been detected. Use this option to keep or clear the record of previous chassis intrusion status.

6.5 Security Screen

The Security Screen lets you change or clear the supervisor / user passwords for the system.

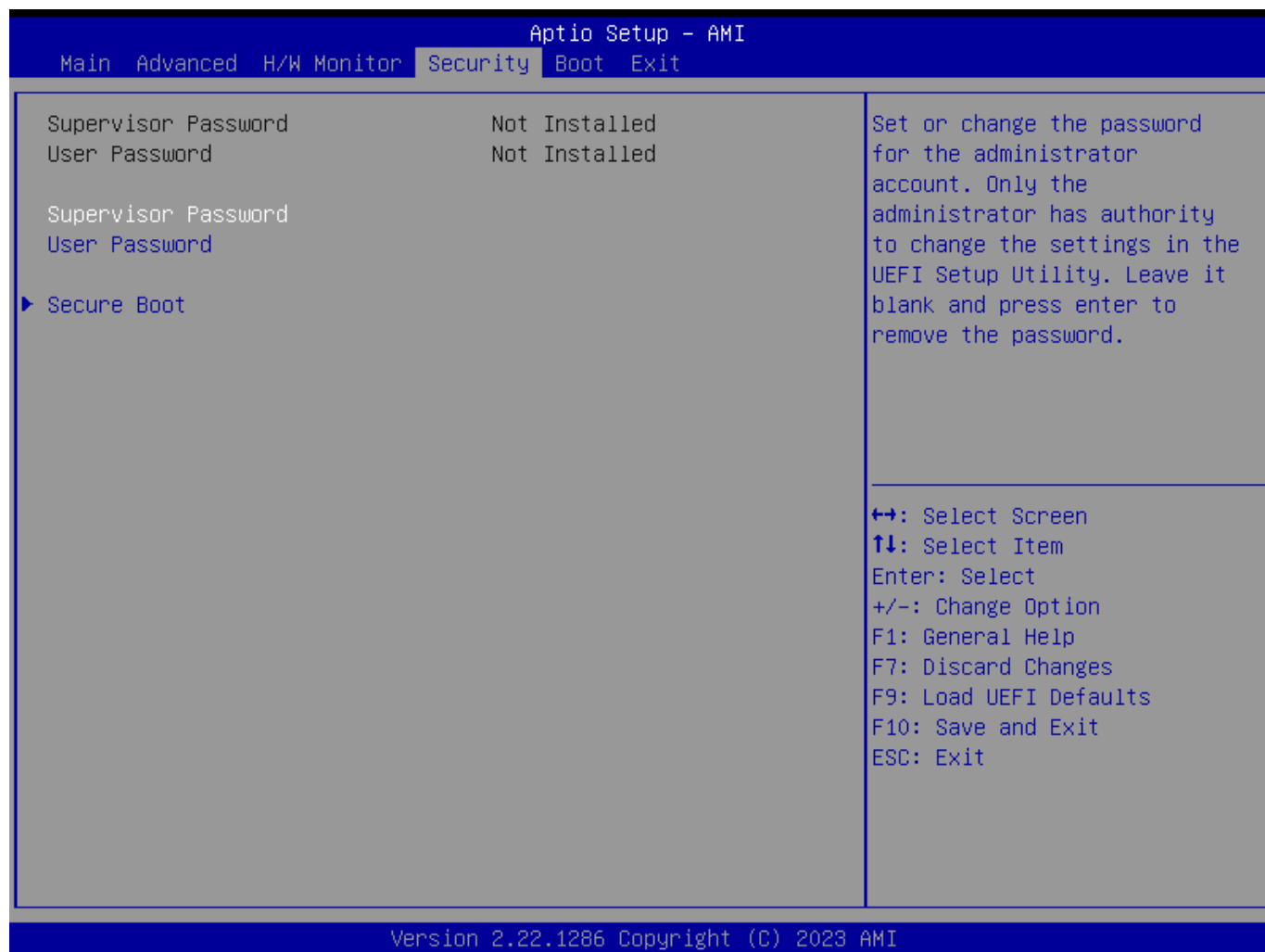

Feature	Description
Supervisor Password	Set or change the password for the administrator account. Only the administrator has the authority to change the settings in the UEFI Setup Utility. Leave it blank and press enter to remove the password.
User Password	Set or change the password for the user account. Users are unable to change the settings in the UEFI Setup Utility. Leave it blank and press enter to remove the password.
Secure Boot	Press [Enter] to configure the Secure Boot Settings. The feature protects the system from unauthorized access and malwares during POST.



Feature	Description
Secure Boot Mode	[Standard] Select this item and the system will automatically load the Secure Boot keys from the BIOS database. [Custom] Select this item and Secure Boot Policy variables can be configured by a physically present user without full authentication.
Install Default Secure Boot Keys	Please install default secure boot keys if it's the first time you use secure boot.
Clear Secure Boot Keys	This item appears only when you load the default Secure Boot keys. Use this item to clear all default Secure Boot keys.
Key Management	This item enables expert users to modify Secure Boot Policy variables without full authentication. This appears only when you set Secure Boot Mode to [Custom].

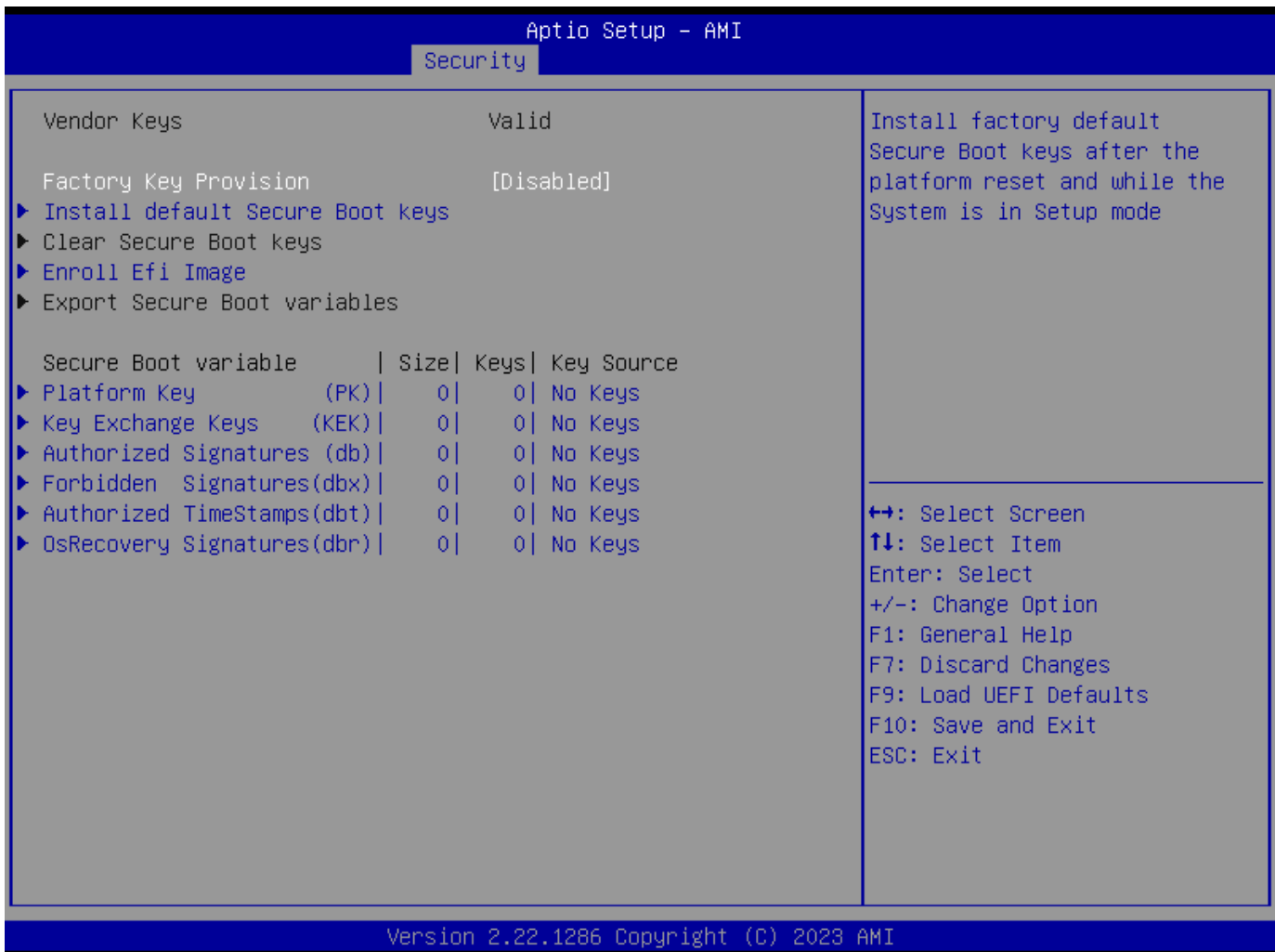

Feature	Description
Factory Key Provision	Allows you to install factory default Secure Boot keys after the platform reset and while the System is in Setup mode.
Install Default Secure Boot Keys	Please install default secure boot keys if it's the first time you use secure boot.
Clear Secure Boot Keys	This item appears only when you load the default Secure Boot keys. Use this item to clear all default Secure Boot keys.
Enroll Efi Image	Allows Efi image to run in Secure Boot Mode. Enroll SHA256 Hash certificate of a PE image into Authorized Signature Database (db).
Export Secure Boot variables	Allows you to copy NVRAM content of Secure Boot variables to files in a root folder on a file system device.
Platform Key(PK)	Enroll Factory Defaults or load certificates from a file: 1. Public Key Certificate: a) EFI_SIGNATURE_LIST b) EFI_CERT_X509 (DER) c) EFI_CERT_RSA2048 (bin) d) EFI_CERT_SHAXXX 2. Authenticated UEFI Variable 3. EFI PE/COFF Image(SHA256) Key Source: Factory, Modified, Mixed

Feature	Description
Key Exchange Keys	Enroll Factory Defaults or load certificates from a file: 1. Public Key Certificate: a) EFI_SIGNATURE_LIST b) EFI_CERT_X509 (DER) c) EFI_CERT_RSA2048 (bin) d) EFI_CERT_SHAXXX 2. Authenticated UEFI Variable 3. EFI PE/COFF Image(SHA256) Key Source: Factory, Modified, Mixed
Authorized Signatures	Enroll Factory Defaults or load certificates from a file: 1. Public Key Certificate: a) EFI_SIGNATURE_LIST b) EFI_CERT_X509 (DER) c) EFI_CERT_RSA2048 (bin) d) EFI_CERT_SHAXXX 2. Authenticated UEFI Variable 3. EFI PE/COFF Image(SHA256) Key Source: Factory, Modified, Mixed
Forbidden Signatures	Enroll Factory Defaults or load certificates from a file: 1. Public Key Certificate: a) EFI_SIGNATURE_LIST b) EFI_CERT_X509 (DER) c) EFI_CERT_RSA2048 (bin) d) EFI_CERT_SHAXXX 2. Authenticated UEFI Variable 3. EFI PE/COFF Image(SHA256) Key Source: Factory, Modified, Mixed
Authorized TimeStamps	Enroll Factory Defaults or load certificates from a file: 1. Public Key Certificate: a) EFI_SIGNATURE_LIST b) EFI_CERT_X509 (DER) c) EFI_CERT_RSA2048 (bin) d) EFI_CERT_SHAXXX 2. Authenticated UEFI Variable 3. EFI PE/COFF Image(SHA256) Key Source: Factory, Modified, Mixed
OsRecovery Signatures	Enroll Factory Defaults or load certificates from a file: 1. Public Key Certificate: a) EFI_SIGNATURE_LIST b) EFI_CERT_X509 (DER) c) EFI_CERT_RSA2048 (bin) d) EFI_CERT_SHAXXX 2. Authenticated UEFI Variable 3. EFI PE/COFF Image(SHA256) Key Source: Factory, Modified, Mixed

6.6 Boot Screen

This section displays the available devices on your system for you to configure the boot priority and settings.

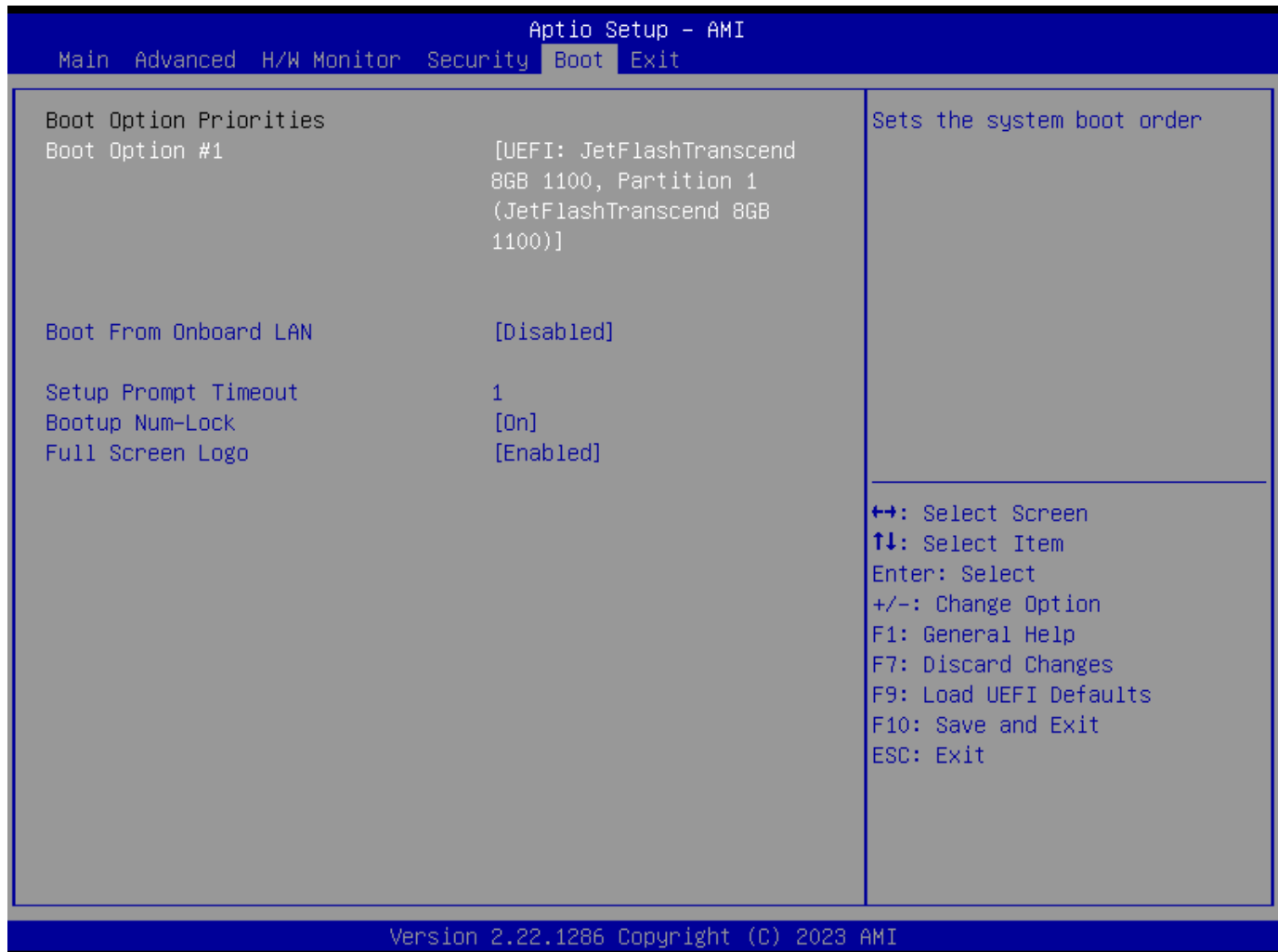

Feature	Description
Boot Option #1	The item allows you to set the system boot order.
Boot From Onboard LAN	The item allows the system to be waked up by the onboard LAN. Configuration options: [Enabled] [Disabled]
Setup Prompt Timeout	The item allows you to configure the number of seconds to wait for the UEFI setup utility. Configuration options: [1] - [65535]
Bootup Num-Lock	The item allows you to select whether Num Lock should be turned on or off when the system boots up. Configuration options: [On] [Off]
Full Screen Logo	[Enabled] Select this item to display the boot logo. [Disabled] Select this item to show normal POST messages.

6.7 Exit Screen

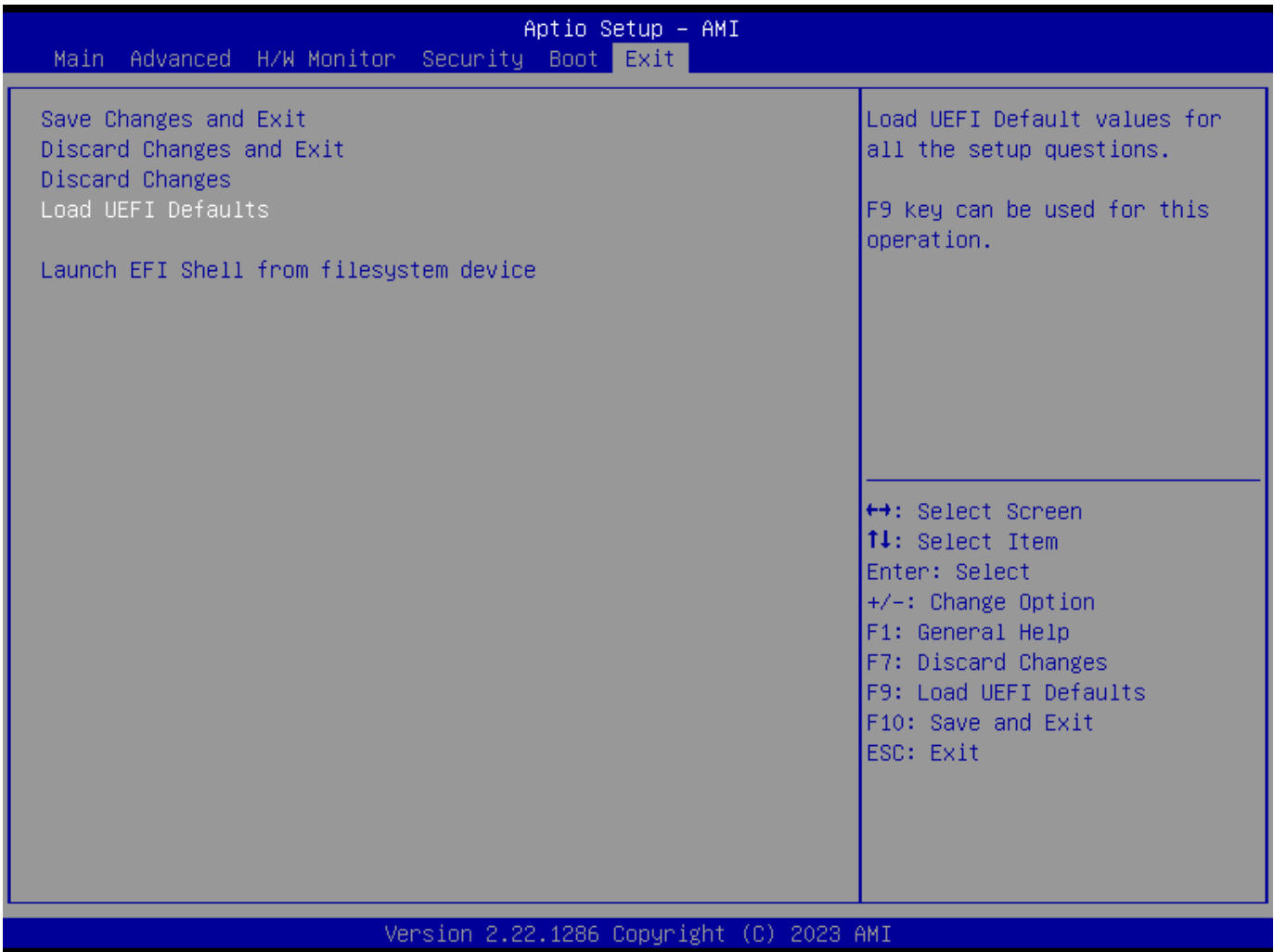

Feature	Description
Save Changes and Exit	When you select this option, the following message “Save configuration changes and exit setup?” will pop out. Select [Yes] to save the changes and exit the UEFI SETUP UTILITY.
Discard Changes and Exit	When you select this option, the following message “Discard changes and exit setup?” will pop out. Select [Yes] to exit the UEFI SETUP UTILITY without saving any changes.
Discard Changes	When you select this option, the following message “Discard changes?” will pop out. Select [Yes] to discard all the changes.
Load UEFI Defaults	The item allows you to load UEFI default values for all options. The F9 key can be used for this operation.
Launch EFI Shell from file system device	The item allows you to copy shellx64.efi to the root directory to launch EFI Shell.

Safety Instructions

Read and follow all instructions marked on the product and in the documentation before you operate your system. Retain all safety and operating instructions for future use.

- Please read these safety instructions carefully.
- Please keep this User's Manual for later reference.
- Read the specifications section of this manual for detailed information on the operating environment of this equipment.
- When installing/mounting or uninstalling/removing equipment, turn off the power and unplug any power cords/cables.
- To avoid electrical shock and/or damage to equipment:
 - Keep equipment away from water or liquid sources.
 - Keep equipment away from high heat or high humidity.
 - Keep equipment properly ventilated (do not block or cover ventilation openings).
 - Make sure to use recommended voltage and power source settings.
 - Always install and operate equipment near an easily accessible electrical socket-outlet.
 - Secure the power cord (do not place any object on/over the power cord).
 - Only install/attach and operate equipment on stable surfaces and/or recommended mountings.
 - If the equipment will not be used for long periods of time, turn off and unplug the equipment from its power source.
- Never attempt to fix the equipment. Equipment should only be serviced by qualified personnel.

Getting Service

Ask an Expert: <https://www.adlinktech.com/en/Askanexpert>

ADLINK Technology, Inc.

Address: No. 66, Huaya 1st Road, Guishan District
Taoyuan City 333, Taiwan
Tel: +886-3-216-5088
Fax: +886-3-328-5723
Email: service@adlinktech.com

Ampro ADLINK Technology, Inc.

Address: 6450 Via Del Oro, San Jose, CA 95119-1208, USA
Tel: +1-408-360-0200
Toll Free: +1-800-966-5200 (USA only)
Fax: +1-408-600-1189
Email: info@adlinktech.com

ADLINK Technology (China) Co., Ltd.

Address: 300 Fang Chun Rd., Zhangjiang Hi-Tech Park, Pudong New Area
Shanghai, 201203 China
Tel: +86-21-5132-8988
Fax: +86-21-5132-3588
Email: market@adlinktech.com

ADLINK Technology GmbH

Address: Hans-Thoma-Strasse 11, D-68163, Mannheim, Germany
Tel: +49-621-43214-0
Fax: +49-621 43214-30
Email: emea@adlinktech.com

Please visit the Contact page at www.adlinktech.com for information on how to contact the ADLINK regional office nearest you.