

COM Express Type 6 Starter Kit Plus

Quick Start Guide



COM 
Express®

Manual Rev.: 2.1

Revision Date: October 12, 2017

Part Number: 50-1J039-1010

Preface

Copyright

Copyright 2017 ADLINK Technology, Inc. This document contains proprietary information protected by copyright. All rights are reserved. No part of this manual may be reproduced by any mechanical, electronic, or other means in any form without prior written permission of the manufacturer.

Disclaimer

The information in this document is subject to change without prior notice in order to improve reliability, design, and function and does not represent a commitment on the part of the manufacturer. In no event will the manufacturer be liable for direct, indirect, special, incidental, or consequential damages arising out of the use or inability to use the product or documentation, even if advised of the possibility of such damages.

Environmental Responsibility

ADLINK is committed to fulfill its social responsibility to global environmental preservation through compliance with the European Union's Restriction of Hazardous Substances (RoHS) directive and Waste Electrical and Electronic Equipment (WEEE) directive. Environmental protection is a top priority for ADLINK. We have enforced measures to ensure that our products, manufacturing processes, components, and raw materials have as little impact on the environment as possible. When products are at their end of life, our customers are encouraged to dispose of them in accordance with the product disposal and/or recovery programs prescribed by their nation or company.

Trademarks

Product names mentioned herein are used for identification purposes only and may be trademarks and/or registered trademarks of their respective companies.

Revision History

Revision	Description	Date	By
2.00	Initial release	2012-12-07	JC
2.1	Update T6-DDI and Debug card information	2017-10-12	JC

Table of Contents

Preface	ii
1. Introduction	1
1.1. How to Order the Type 6 Starter Kit	1
1.2. What's Included in the Type 6 Starter Kit Plus	2
2. Getting Started	5
2.1. Unpacking.....	5
2.2. Board Installation	7
2.3. Power and I/O Connectors	9
2.4. Powering Up the Express-BASE6 System	10
3. T6-DDI Video Adapter Card	13
3.1. HDMI / DP Output Setting.....	14
3.2. T6-DDI Video Adapter Card Installation	15
4. PCIe x16 to two PCIe x8 Adapter Card	17
5. Debug Card	19
5.1. Connecting the COM Express Module and Debug Card	20
5.2. Buttons and Switches	20
5.3. Display and LEDs	21
Safety Instructions	23
Getting Service	24

This page intentionally left blank.

1. Introduction

The Type 6 Starter Kit Plus is intended for testing and verification of COM Express systems based on Type 6 modules and includes everything customers need to begin their own design and development. The Type 6 Starter Kit Plus includes the Express-BASE6 ATX size COM Express Type 6 reference carrier board, a COM Express Type 6 module (of your choice), memory (of your choice), thermal solution (heatspreader or heatsink, of your choice) and additional items such as a debug card, cabling, and ATX power supply.

The complete kit allows customers to quickly emulate the functionality of their end product for software development and hardware verification. Drivers, BSP, carrier board design files (including schematics, mechanical drawings and BOM), certificates, test reports, COM Express module user's manual and thermal solution drawing (specific to your chosen configuration) are included to assist customers in designing their own custom carrier board.

The Type 6 Starter Kit Plus also includes additional development cards, such as a DDI video adapter card for HDMI and DisplayPort verification (T6-DDI), a PCIe x16 to two PCIe x8 adapter card (P16TO28) and a debug card (DB40).









The Type 6 Starter Kit Plus also includes a USB flash drive with SEMA pre-installed in a Linux OS environment. This helps customers quickly review the features provided by the EAPI.

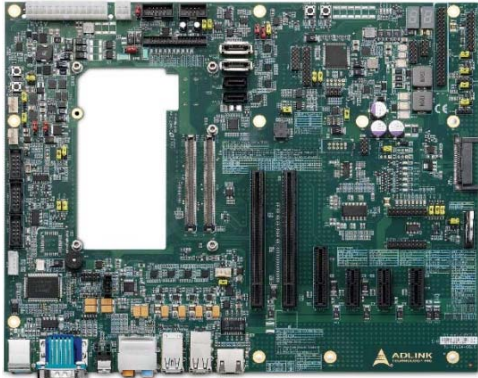

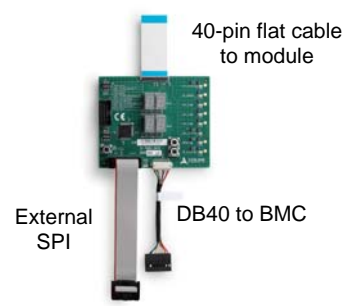
1.1. How to Order the Type 6 Starter Kit





1.2. What's Included in the Type 6 Starter Kit Plus

1.2.1. Standard Items

No.	Photo	Part Number	Description
1.		91-77104-0060	Express-BASE6 Type 6 reference carrier board
2.		91-79302-0020	T6-DDI COM Express Type 6 DDI-to-HDMI/DVI/DisplayPort adapter card
3.		91-79301-0010	PCIe x16 to two PCIe x8 adapter card (P16TO28)
4.	 <p>40-pin flat cable to module</p> <p>External SPI</p> <p>DB40 to BMC</p>	91-79007-0020 30-30016-0000 30-10192-0000 30-20736-0000	Debug Card (DB40) 40-pin flat cable External SPI cable (used for BIOS update) DB40 to BMC cable (used for BMC FW update)
5.		31-32220-0000	Power Supply Unit
6.		29-02480-0040	USB Flash Drive (2pcs) One containing documents One with SEMA pre-installed in Linux OS
7.		30-01120-0020	DisplayPort to DVI cable
8.		30-10057-5010	7-pin SATA cable 180° (-) to 180°
9.		30-20171-1000	SATA Power to Molex 4-pin cable

10.		30-20027-3000	PSU Converter Harness ATX 20-pin to 24-pin
11.		30-00001-0030	US Power Cord , 10A, 125V
12.		30-00002-0010	EU Power Cord , 220V

1.2.2. Optional Items

No.	Photo	Part Number	Description
1.		-	COM Express Type 6 module of your choice
2.		-	Memory module(s) of your choice
3.		-	Thermal solution of your choice

This page intentionally left blank.

2. Getting Started

2.1. Unpacking

Check that the EPE foam layers contain the items shown below:





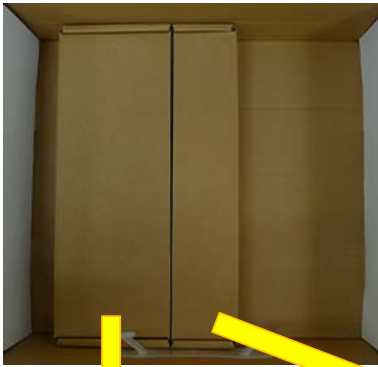



Remove the EPE foam layers and check accessory boxes contain items shown below:

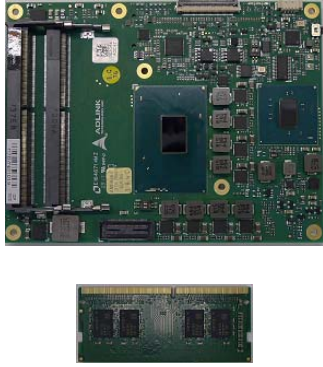
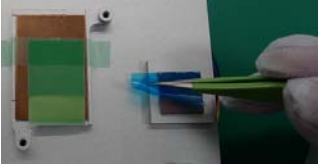
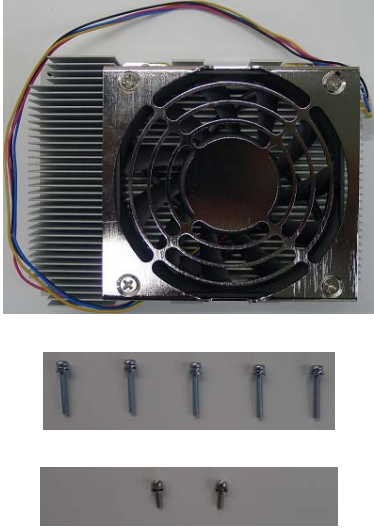
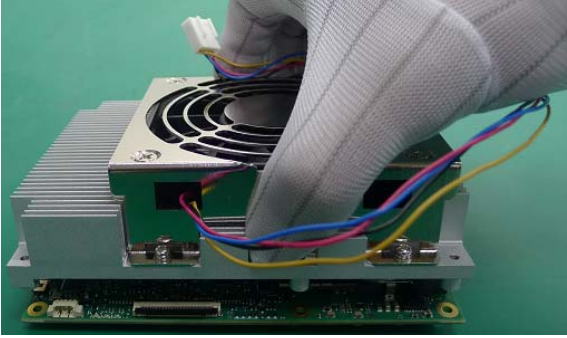

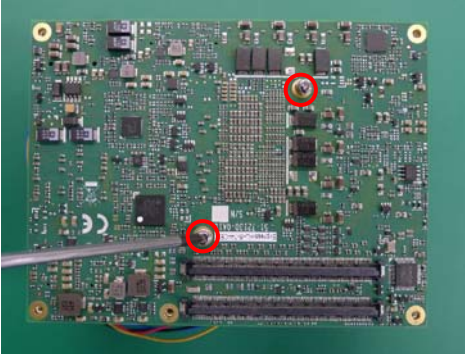



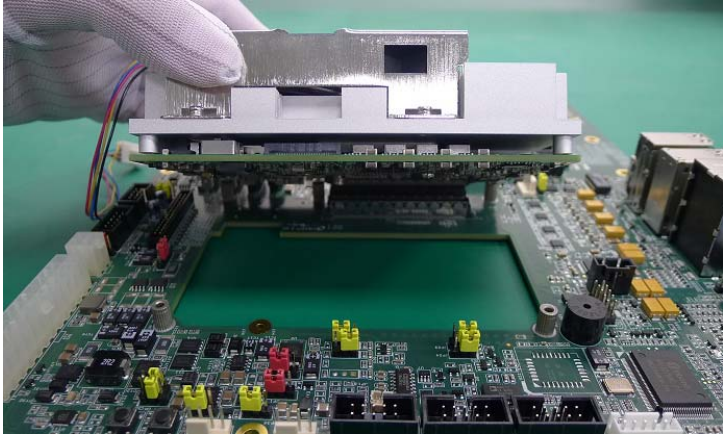
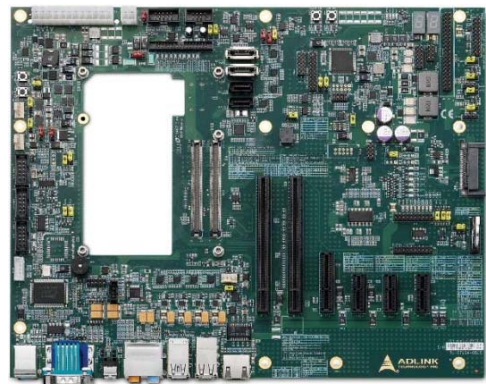
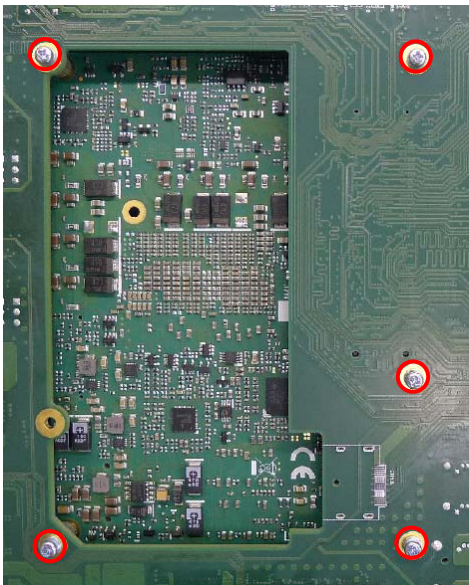

Cables for DB40

2.2. Board Installation

Procedure	Required Items
<p>Step 1 Insert SO-DIMM memory into the COM Express Type 6 module's SO-DIMM socket.</p> 	
<p>Step 2 Removed all protective membranes from the thermal pads.</p> 	
<p>Step 3 Assemble the thermal solution onto the COM Express Type 6 module.</p> 	
<p>Step 4 Use the M2.5, L=6mm screws provided to fasten the thermal solution to the COM Express Type 6 module.</p> 	

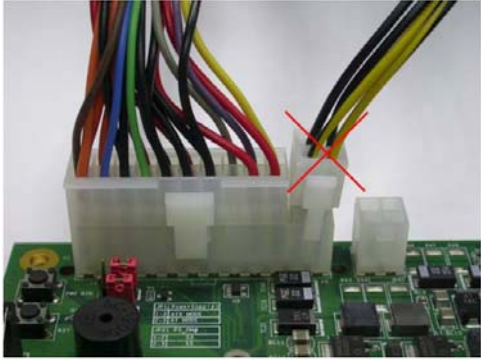
Procedure	Required Items
<p>Step 5 Place the COM Express Type 6 module and thermal solution assembly onto the connectors on the carrier board as shown.</p> 	
<p>Step 6 Use the M2.5, L=16mm screws provided to secure the COM Express Type 6 module to the carrier board from the solder side.</p> 	
<p>Step 7 If you are installing a heatsink with fan, plug the fan connector into the carrier board as shown.</p> 	<p>None</p>

2.3. Power and I/O Connectors



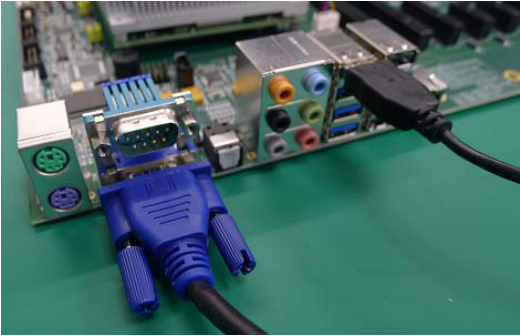
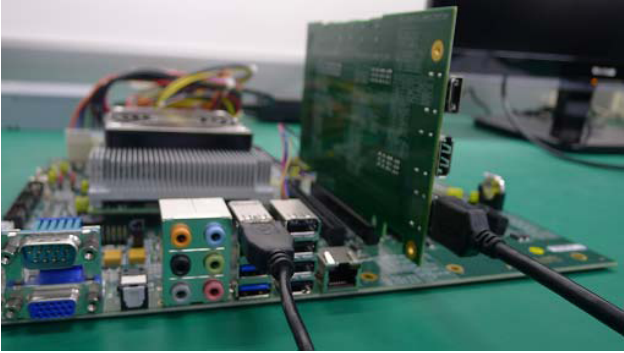

Connect the Power Supply	Required Items
<p>Plug the ATX connector of the power supply into CN1 and plug the ATX 12V 4-pin connector of the power supply into CN5.</p> 	
 <p> CAUTION: DO NOT plug the ATX 12V 4-pin connector into the ATX 24-pin power connector.</p>	
<p>Plug the AC power cord into the power supply.</p> 	

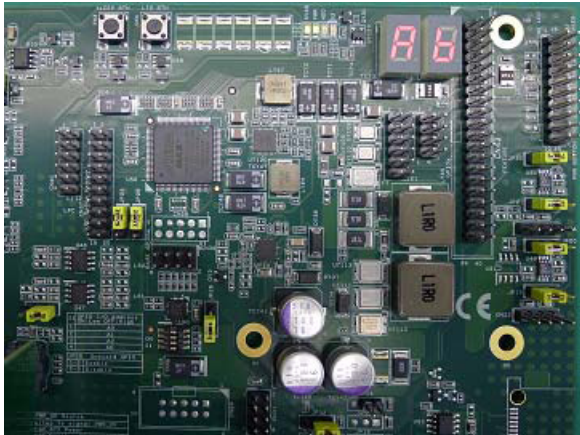
Connect the Keyboard, Mouse and Monitor	Required Items
<p>Plug keyboard, mouse and VGA cable (if selected COM Express module support VGA output) into the Express-BASE6.</p>  <p>Or Plug keyboard, mouse, T6-DDI card and DP/HDMI cable (if selected COM Express module support DDI output in place of VGA output) (please refer to Chapter 3 for T6-DDI card installation)</p> 	<p>None</p>

2.4. Powering Up the Express-BASE6 System

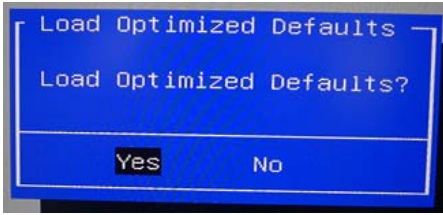
Powering up the Express-BASE6 system	Required Items
<p>The POST LEDs on the Express-BASE6 will display the bootup status – “Ab or Ad” indicates a successful boot.</p>  <p>Note: “Ad” indicates boot to UEFI shell “Ab” indicates boot to BIOS setup menu, by pressing DEL (delete key)</p>	<p>None</p>

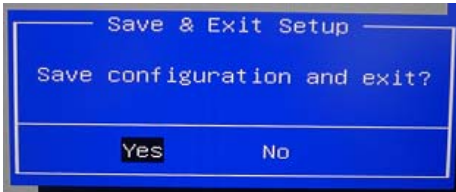
First Boot into UEFI Shell or BIOS setup menu	Required Items
<p>If no operating system is installed on the system, then the monitor will display the UEFI shell or BIOS setup menu after the first boot up.</p> 	None

How to quick load BIOS default settings	Required Items
<p>Press the <F9> key to bring up the “Load Optimized Defaults” window as shown.</p>   <p>Press the <Enter> key to load optimized BIOS defaults.</p>  <p>Press the <F10> key to bring up the “Save & Exit” window as shown.</p>   <p>Press the <Enter> key to save the configuration.</p> 	None

This page intentionally left blank.

3. T6-DDI Video Adapter Card

The T6-DDI Video Adapter Card provides connector access to the COM Express Type 6 module's Digital Display Interface (DDI) ports which can be individually set to HDMI or DisplayPort output mode.

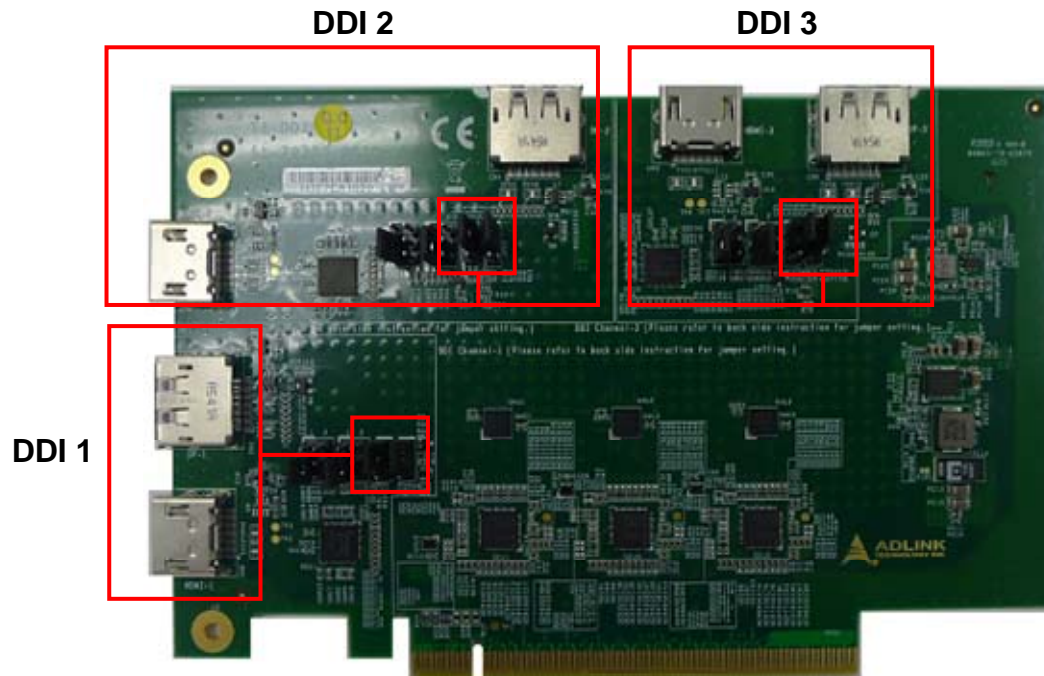

3.1. HDMI / DP Output Setting

Jumper Settings for DisplayPort Output

Short pins 1-2 of the jumpers for each DDI port you wish to set DisplayPort output mode.
Take DDI 1 port (JP1 & JP10 jumpers) as example shown below

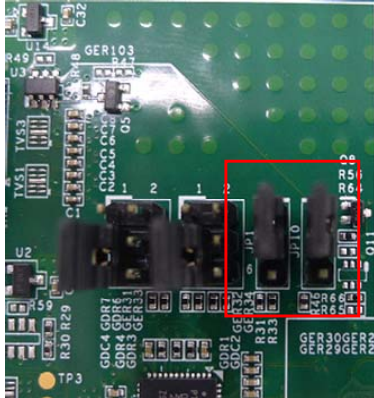

DDI 1 port: JP1 & JP10

DDI 2 port: JP4 & JP11

DDI 3 port: JP7 & JP12

Jumper Settings for HDMI Output

Short pins 2-3 of the jumpers for each DDI port you wish to set HDMI output mode.
Take DDI 1 port (JP1 & JP10 jumpers) as example shown below

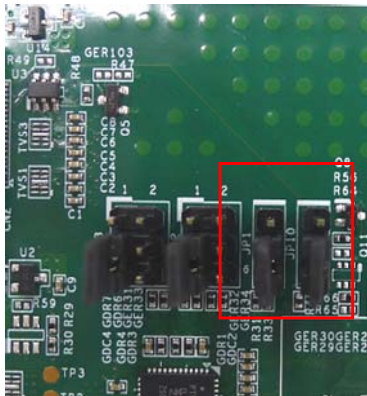

DDI 1 port: JP1 & JP10

DDI 2 port: JP4 & JP11

DDI 3 port: JP7 & JP12

3.2. T6-DDI Video Adapter Card Installation

T6-DDI Installation

Plug the T6-DDI card into the DDI1 slot of the Express-BASE6 carrier board.



Plug display cable into the desired T6-DDI card connector (DDI 1 port & HDMI output shown)



DVI Display Output

A DisplayPort-to-DVI cable is included with the T6-DDI as shown.



To connect the T6-DDI card DisplayPort output to a DVI monitor, please use this cable.

This page intentionally left blank.

4. PCIe x16 to two PCIe x8 Adapter Card

The PCIe x16 to two PCIe x8 Adapter Card allows the use of two PCIe x8 add-on cards from a single PCIe x16 slot



Insert the adapter card into the PEG1 slot of the Express-BASE6 carrier board as shown below.



Insert PCIe x8 cards as required into the PCIe x8 slots of the adapter card.



This page intentionally left blank.

5. Debug Card

The DB40 Debug Card provides COM Express.system debugging functions and includes the following features:

- **Port 80/81 Decoding Interface** with LED hexadecimal display for Power On Self Test (POST) via LPC interface
- **Interface to SPI Flash** for BIOS update
- **Interface to BMC** for Board Management Controller (BMC) update
- **Buttons** for Power and Reset
- **Status LEDs** for Power Button, Reset Button, CB_PWROK, CB_RESET#, SLP_S3#, SLP_S4#, SLP_S5#

The DB40 Debug Card can only be used with COM Express products that have the appropriate 40-pin flat flexible connector (FFC).

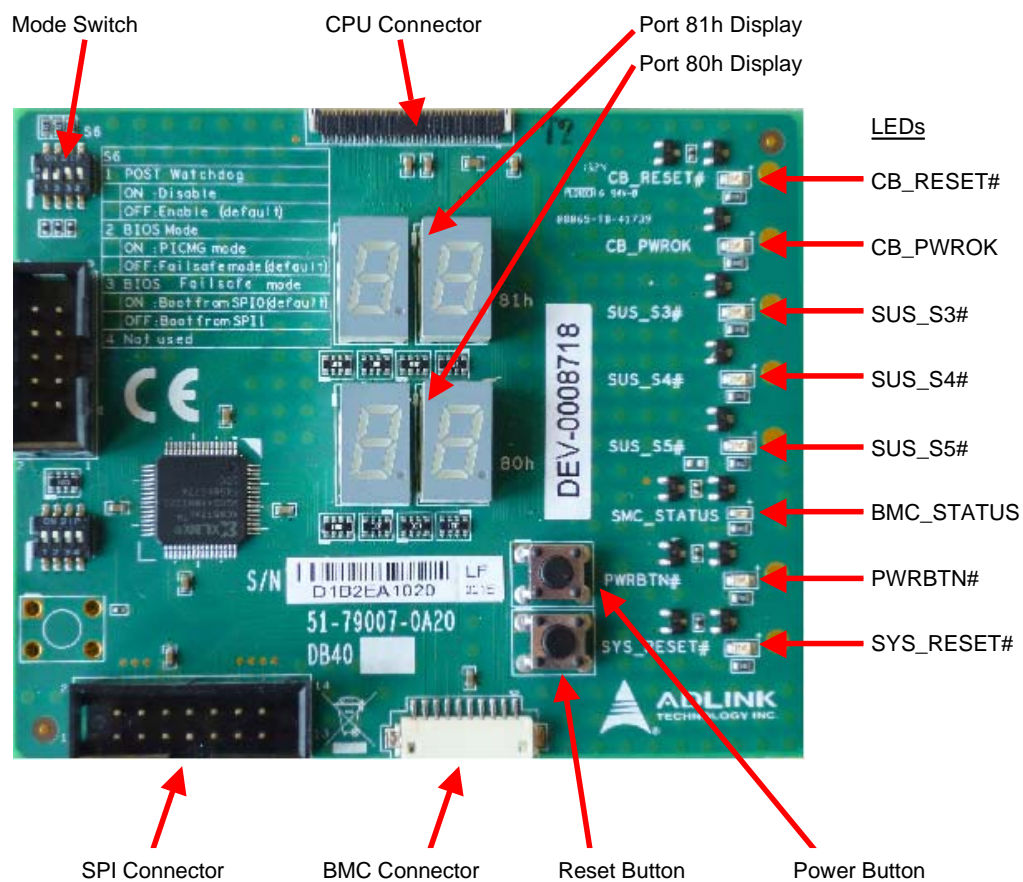

5.1. Connecting the COM Express Module and Debug Card

Connect the COM Express module to the DB40 debug card using the 40-pin flat cable provided (P/N: 30-30016-0000).

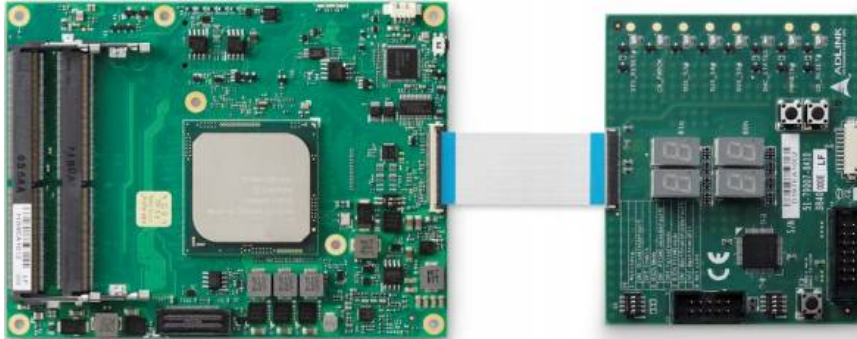

5.2. Buttons and Switches

This section describes the buttons and switches on the DB40 debug card.

Power Button: toggles the PWRBTN# signal of the COM Express module.

Reset Button: toggles the SYS_RESET# signal of the COM Express module.

Mode Switch: this 4-pole DIP switch selects several modes :

Switch	Function
1	POST Watchdog ON = Disable OFF = Enable (default)
2	BIOS Mode ON = PICMG Mode OFF = Failsafe Mode (default)
3	BIOS Failsafe Mode ON = Boot from SPI0 (default) OFF = Boot from SPI1
4	Not used

5.3. Display and LEDs

This section describes the hexadecimal display and LED functionality.

5.3.1. Bootup Procedure

During power-up and BIOS execution the CPU will first retrieve commands from POST and then execute them. Each command has a corresponding debug port data code or BIOS POST checkpoint code. The results from each checkpoint can be viewed on the DB40 Debug Card's LED display, allowing the technician or administrator to debug the system. The POST code is written to I/O port 80h, and for extended POST codes port 80h and 81h are used.

The POST code is shown on the two 7-segment LED displays on the board

5.3.2. LED Table

The following LEDs indicate status of system signals as shown in the table below.

LED	Function
CB_RESET#	LED lights on active reset signal of carrier board
CB_PWROK	LED lights on active power-OK from COM Express module
SUS_S3#	LED lights on released SUS_S3# signal from COM Express module
SUS_S4#	LED lights on released SUS_S4# signal from COM Express module
SUS_S5#	LED lights on released SUS_S5# signal from COM Express module
BMC_STATUS	LED shows the status of the BMC on the COM Express module
PWRBTN#	LED lights on active power button signal of COM Express module
SYS_RESET#	LED lights on active reset signal of COM Express module

5.3.3. BMC Status

The BMC_STATUS LED shows the status of the BMC on the COM Express module.

Behavior (blue)	Description
Blinking	A blinking BMC_STATUS LED indicates a failure during power up. The number of flashes indicates the error code. A missing/wrong system voltage, stuck on the reset line, BIOS failure or an unexpected shutdown of an onboard power supply is displayed by this signaling code. The error code is board specific (refer to the user's manual for your COM Express module).
Bright flash	A system state change occurs. Power-button activity, Reset-button activity, PCI_RST# activity or activity on the SLP_Sx signals is shown by this signaling mode.
Fast blinking	If the board is running on Fail-Safe-BIOS, the BMC_STATUS LED blinks very quickly.
Short bright flash every 4 seconds	System is in Suspend-to-RAM or Suspend-to-Disk state.

This page intentionally left blank.

Safety Instructions

Read and follow all instructions marked on the product and in the documentation before you operate your system. Retain all safety and operating instructions for future use.

- Please read these safety instructions carefully.
- Please keep this User's Manual for later reference.
- The equipment should be operated only from the type of power source indicated on the rating label. Make sure the voltage of the power source when connect the equipment to the power outlet.
- If your equipment has a voltage selector switch, make sure that the switch is in the proper position for your area. The voltage selector switch is set at the factory to the correct voltage.
- For pluggable equipment, that the socket-outlet shall be installed near the equipment and shall be easily accessible.
- Place the power cord such a way that people can not step on it. Do not place anything over the power cord.
- If the equipment is not use for long time, disconnect the equipment from mains to avoid being damaged by transient overvoltage.
- All cautions and warnings on the equipment should be noted.
- Please keep this equipment from humidity.
- Do not use this equipment near water or a heat source.
- Lay this equipment on a reliable surface when install. A drop or fall could cause injury.
- Never pour any liquid into opening; this could cause fire or electrical shock.
- Openings in the case are provided for ventilation. Do not block or cover these openings. Make sure you provide adequate space around the system for ventilation when you set up your work area. Never insert objects of any kind into the ventilation openings.
- To avoid electrical shock, always unplug all power cables and modem cables from the wall outlets before removing covers.
- Lithium Battery provided (real time clock battery)

CAUTION – Risk of explosion if battery is replaced with one of an incorrect type. Dispose of used batteries according to the instructions

- If one of the following situations arises, get the equipment checked by a service personnel:
 - The power cord or plug is damaged.
 - Liquid has penetrated into the equipment.
 - The equipment has been exposed to moisture.
 - The equipment has not work well or you can not get it work according to user's manual.
 - The equipment has dropped and damaged.
 - If the equipment has obvious sign of breakage.

Getting Service

Ask an Expert: <http://askanexpert.adlinktech.com>

ADLINK Technology, Inc.

Address: 9F, No.166 Jian Yi Road, Zhonghe District
New Taipei City 235, Taiwan
Tel: +886-2-8226-5877
Fax: +886-2-8226-5717
Email: service@adlinktech.com

Ampro ADLINK Technology, Inc.

Address: 5215 Hellyer Avenue, #110, San Jose, CA 95138, USA
Tel: +1-408-360-0200
Toll Free: +1-800-966-5200 (USA only)
Fax: +1-408-360-0222
Email: info@adlinktech.com

ADLINK Technology (China) Co., Ltd.

Address: 300 Fang Chun Rd., Zhangjiang Hi-Tech Park, Pudong New Area
Shanghai, 201203 China
Tel: +86-21-5132-8988
Fax: +86-21-5132-3588
Email: market@adlinktech.com

LiPPERT ADLINK Technology GmbH

Address: Hans-Thoma-Strasse 11, D-68163, Mannheim, Germany
Tel: +49-621-43214-0
Fax: +49-621 43214-30
Email: emea@adlinktech.com

Please visit the Contact page at www.adlinktech.com for information on how to contact the ADLINK regional office nearest you.